

Technical development of rotary desiccant dehumidification and air conditioning: A review

D. La, Y.J. Dai^{*}, Y. Li, R.Z. Wang, T.S. Ge

Institute of Refrigeration and Cryogenics, Shanghai Jiao Tong University, Shanghai 200240, PR China

ARTICLE INFO

Article history:

Received 10 June 2009

Accepted 14 July 2009

Keywords:

Desiccant dehumidification

Solar energy

Low grade thermal energy

Air conditioning

ABSTRACT

Rotary desiccant air conditioning system, which combines the technologies of desiccant dehumidification and evaporative cooling, is advantageous in being free from CFCs, using low grade thermal energy and controlling humidity and temperature separately. Compared with conventional vapor compression air conditioning system, it preserves the merits of environment-friendly, energy saving, healthy, comfortable, etc. Ongoing research and development works suggest that new desiccant materials and novel system configurations have significant potential for improving the performance and reliability and reducing the cost and size of rotary desiccant dehumidification and air conditioning system, thereby increasing its market competitiveness and breaking out the current fairly small niche market. For the purpose of providing an overview of recent efforts on these issues and showing how rotary desiccant air conditioning systems can be designed and coupled to available thermal energy, this paper presents and analyzes the status of rotary desiccant dehumidification and air conditioning in the following three aspects: the development of advanced desiccant materials, the optimization of system configuration and the utilization of solar energy and other low grade heat sources, such as solar energy, district heating, waste heat and bioenergy. Some key problems to further push forward the research and development of this technology are also summarized.

© 2009 Elsevier Ltd. All rights reserved.

Contents

1. Introduction	131
2. Advanced desiccant materials	131
3. Progress in system configuration	132
3.1. Basic rotary desiccant dehumidification and air conditioning processes	133
3.2. Staged regeneration	134
3.3. Isothermal dehumidification	135
3.4. Hybrid desiccant air conditioning systems	136
3.4.1. Hybrid desiccant and VAC unit	137
3.4.2. Hybrid desiccant and absorption chiller	137
3.4.3. Hybrid desiccant and adsorption chiller	138
3.4.4. Hybrid desiccant and chilled-ceiling	138
3.5. Desiccant air conditioning system producing both dry air and chilled water	138
4. Recent application	139
4.1. Solar driven rotary desiccant air conditioning systems	139
4.2. Rotary desiccant air conditioning systems powered by other low grade heat sources	143
5. Conclusions and perspectives	144
Acknowledgements	145
References	145

^{*} Corresponding author. Tel.: +86 21 3420 4358; fax: +86 21 3420 6814.

E-mail address: yjdai@sjtu.edu.cn (Y.J. Dai).

1. Introduction

Desiccant materials attract moisture based on differences in vapor pressure. Due to their enormous affinity to sorb water and considerable ability to hold water, desiccants have been widely applied to marine cargo, pharmaceutical, electronics, plastics, food, storage, etc. [1]. Recently, the rapid development of desiccant air conditioning technology, which can handle sensible and latent heat loads independently without using CFCs and consuming a large amount of electric power, and thus meet the current demands of occupant comfort, energy saving and environmental protection, has expanded desiccant industry to a broader niche applications, such as hospitals, supermarkets, restaurants, theaters, schools and office buildings.

The basic idea of desiccant air conditioning is to integrate the technologies of desiccant dehumidification and evaporative cooling together. While the former adopts water as refrigerant and can be driven by low grade thermal energy as solar energy, district heating, waste heat and bioenergy, the later is near-zero cost technology [2]. These indicate that desiccant air conditioning would be not only energy efficient and environment-friendly but also cost-competitive, especially for hot dry and hot humid areas. Besides, since desiccants remove moisture in the vapor phase without liquid condensate, desiccant dehumidification can continue even when the dew point of the air is below freezing; in contrast, cooling-based dehumidification is limited by freezing phenomenon occurring at 0 °C. As a result, desiccant air conditioning is capable of handling the dew point of the air to –40 °C [3], whereas the counterpart of traditional vapor compression air conditioning (VAC) is 4 °C [4].

As desiccants can be either solid or liquid, desiccant air conditioning systems can be classified into two categories, namely, solid desiccant air conditioning systems, which consist of fixed bed type and rotary wheel type, and liquid desiccant air conditioning systems. Due to being advantageous in handling latent heat load, all these technologies have been used widely. Especially, rotary desiccant air conditioning systems, which are compact and less subject to corrosion and can work continuously, attract more attention. To date, extensive studies on rotary desiccant air conditioning have been carried out on the basis of mathematical simulation [5–7], thermodynamic analysis [8–10], experimental investigation [11–13] and practical application [14–16]. A lot of academic societies, research institutes, universities, companies, etc. [17], have been involved into these works, and significant improvements in system performance, cost and reliability have been achieved.

Currently, ongoing research and development (R&D) works for rotary desiccant air conditioning technology have been directed at: (1) advanced desiccant materials; (2) optimum system configurations and corresponding practical applications. Earlier conducted works have been introduced in Refs. [18,19]. This paper will mainly focus on the recent efforts on these aspects and some earlier works are also included for consistence and integrity. Moreover, the obstacles and R&D needs for future works are summarized.

2. Advanced desiccant materials

Desiccant materials have been playing a crucial role in the development of desiccant air conditioning. The characteristics of the desiccant material being utilized impact the performance of the desiccant air conditioning systems significantly [20]. Commonly used desiccant materials include activated carbon, activated alumina, molecular sieve, silica gel, lithium chloride, calcium chloride and etc. Two key principles for selecting appropriate desiccant materials are: (1) the desiccant materials should possess large saturated adsorption amount and can be reactivated easily;

(2) the adsorption performance of the desiccant materials should approach the Type 1M material [19], which represents the optimum shape for air conditioning application, as shown in Fig. 1. It should be pointed out that, although the normalized loading fraction (actual desiccant water content at corresponding RH/maximum desiccant water content at RH = 100%) of Type 1E material is higher than that of Type 1M material, it also means more difficult to regenerate due to its nearly complete loading at very low RH [21,22].

Recent investigations on solid desiccant generally consists of four aspects, namely, modification of conventional desiccant [23–27], natural rock-based desiccant [28,29], bio-desiccant [30–34] and composite desiccant [3,35–50]. For rotary desiccant dehumidification, researchers are under way to find desiccant materials that approach the type 1M material in its sorption performance [19], and composites formed by confining salt to porous host adsorbent have been identified to be an effective way [35]. As is known, while the adsorption capacity of silica gel decreases quickly with the rise of temperature, especially when the partial pressure of water vapor is low, lithium chloride and calcium chloride have a higher hygroscopic capacity, but the lyolysis phenomenon, which leads to the loss of desiccant materials and may reduce the performance, often takes place after the formation of solid crystalline hydrate [36]. However, the developed porous silica gel- and haloids-based composite materials not only combine their advantages but also overcome the limited dehumidification capacity of silica gel and the crystallization and corrosion problems of haloids. In addition, corresponding required regeneration temperature is significantly decreased, thereby facilitating the usage of low grade heat sources.

Up to now, R&D efforts on composite desiccant have been performed widely. A number of silica gel-based composite desiccants have been developed. Kuma and Okano [38] have fabricated a silica gel and synthesized zeolite-based composite desiccant. Due to the combination of the merits of silica gel and zeolite, of which the adsorption capacities are favorable under high and low relative humidity, respectively, the composite desiccant material has been found to be capable of exhibiting an excellent humidity adsorbing ability and obtaining an ultra-low dew point, and thus could be applied to dehumidify air of very high humidity and achieve deep dehumidification. However, the processing technology is comparatively complicated. Aristov et al. [39–44] have fabricated some composite adsorbents with inorganic salt (CaCl₂, LiBr, SrCl₂, NaSO₄) and silica gel or SiO₂ sol-gel. The developed composites have been applied to two types of

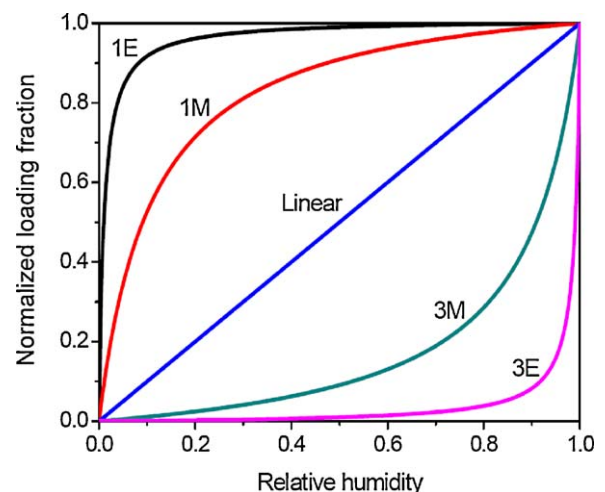

Fig. 1. Comparison between adsorption isotherms of Type 1 extreme (1E), Type 1 moderate (1M), linear, Type 3 moderate (3M), and Type 3 extreme (3E) [21,22].

equipment for adsorbing water from air and the dynamic and equilibrium adsorption performance have been tested. As reported, about 80% adsorbed water could be desorbed with corresponding desorption temperature in the range of 80–90 °C. Liu et al. [45,46] introduced a composite adsorbent $\text{SiO}_2 \cdot x \cdot \text{H}_2\text{O} \cdot y \cdot \text{CaCl}_2$ that was fabricated with macro-porous silica gel and calcium chloride. The impacts of pore structure and mixture ratio were studied. They found that the equilibrium adsorbate uptake of the composite desiccant reached up to 0.4 g $\text{H}_2\text{O}/\text{g}$ dry adsorbent at intake condition of 25 °C and 40% RH, which was 5.7 times that of macro-porous silica gel, 2.1 times that of micro-porous silica gel, 1.9 times that of synthetic zeolite 13X and 6.8 times that of activated carbon. Moreover, the water adsorbed in the adsorbent could be desorbed with low grade heat sources of 60–80 °C. Zhang and Jia [3,36] have investigated on silica gel-based composites impregnated with CaCl_2 and LiCl successively. The experimental research indicated that the moisture removal of the silica gel- CaCl_2 wheel was larger than that of the conventional silica gel wheel by a mean value of about 20% at the regeneration temperature lower than 120 °C under typical hot wet climates. Comparisons between the adsorption isotherms of silica gel- LiCl and traditional desiccants (silica gel and 13X molecular sieve) were performed at classic temperatures (25 °C, 35 °C and 40 °C). The results demonstrated that the adsorption capacity was improved by about 67–145%.

Besides, González et al. [47] have developed two kinds of sepiolite-based composite desiccants, namely sepiolite-activated carbon and sepiolite-calcium chloride. The former combines the hydrophilic and fibrous nature of the sepiolite with the hydrophobic and porous structure of activated carbon and widens the application range of sepiolite (89–39%). The latter improves the adsorption capacity of sepiolite substantially and enhances the ability of sepiolite as humidity controller due to the impregnation of calcium chloride.

By confining CaCl_2 to mesoporous host matrix MCM-41, Tokarev et al. [48] synthesized a new working material. It was reported that, the water sorption was a combination of a liquid absorption and a heterogeneous adsorption. Moreover, although the specific surface area of the MCM-41 reduced from 1050 m^2/g to 325 m^2/g , its absorptivity increased up to 0.75 g water/g dry sorbent, which ensured a high energy storage capacity of 2.1 kJ/g.

On the basis of clay- CaCl_2 , Thoruwa et al. [49] have developed three low cost, solar regenerative composite desiccants. Experimental results of the moisture sorption and regeneration characteristics demonstrated that these materials could be used for solar crop drying and air dehumidification due to the low regeneration temperature sub 100 °C.

Moreover, Mathiowitz et al. [50] have proposed a novel concept for the preparation of desiccants based on polymeric blends.

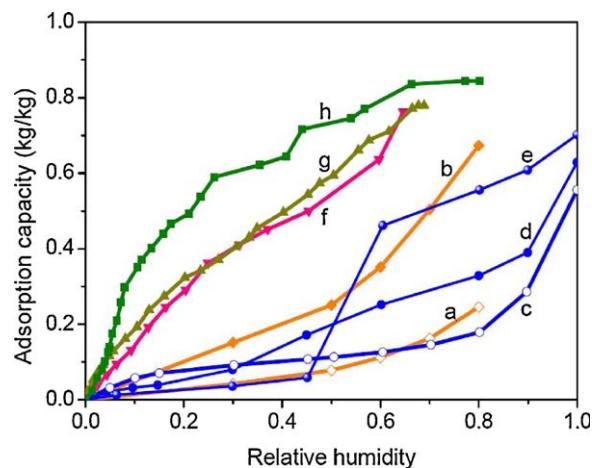

Fig. 2. Water vapor adsorption isotherms for: (a) silica gel at 25 °C [36]; (b) silica gel- LiCl at 25 °C [36]; (c) sepiolite at 23 °C [47]; (d) sepiolite-carbon by physical activation with steam at 23 °C [47]; (e) sepiolite-carbon by chemical activation with KOH at 23 °C [47]; (f) CaCl_2 - SiO_2 sol-gel at 25 °C [43]; (g) CaCl_2 -MCM-41 at 20 °C [48]; (h) silica gel- LiBr at 20 °C [42].

Firstly, a hydrophilic channeling agent is blended with a hydrophobic polymer to produce interconnecting hydrophilic channels within the hydrophobic polymer. Then a water-absorbing material is blended into the polymeric matrix to become distributed within the hydrophilic portion. The composite can be shaped into different figures and is suitable to pharmaceutical and industrial applications.

Fig. 2 shows the water vapor adsorption isotherms of several desiccant materials mentioned above. It is obvious that composite desiccants improve adsorption capacity significantly.

3. Progress in system configuration

Fig. 3 illustrates the basic operating principle of rotary desiccant dehumidifier schematically. As seen, the desiccant material is impregnated into a support structure. The cross section of wheel is divided into process air side and regeneration air side by clapboard. When the wheel constantly rotates through two separate sections, the process air is dried by the desiccant due to the adsorption effects of the desiccant material and support material. At the same time, the regeneration air is humidified after being heated by a heater and desorbing the water from the wheel in tandem. It should be noted that the desiccant dehumidification process is close to an isenthalpic procedure, namely, it merely converts latent energy to sensible energy and produces no useful cooling. Therefore, in order to accommodate cooling effect, auxiliary

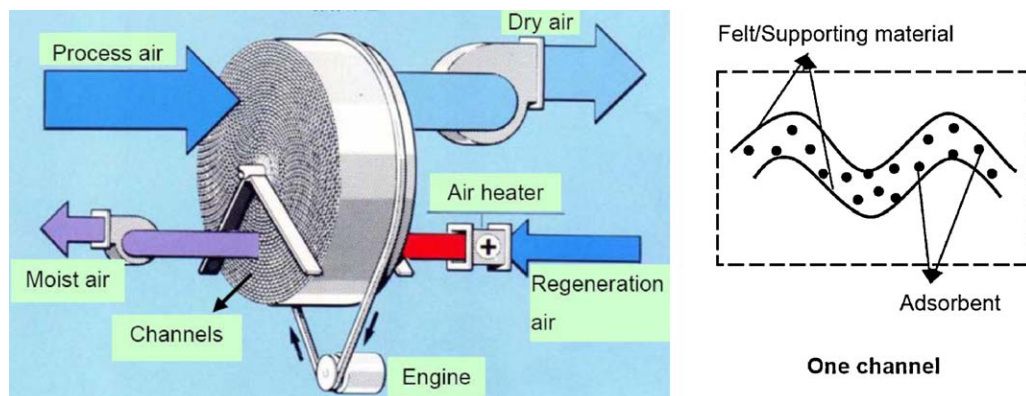

Fig. 3. Schematic diagram of rotary desiccant dehumidifier [7].

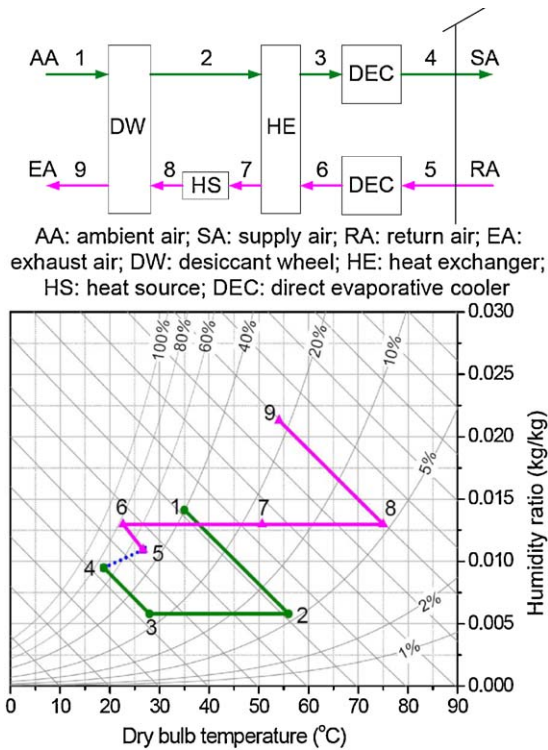

Fig. 4. Pennington cycle.

cooler, like evaporative cooler and other air conditioning equipments, must be incorporated to remove the sensible heat; and the performance of desiccant air conditioning systems are principally determined by the system configuration when the desiccant material, wheel structure and operation condition are invariant. For this reason, extensive types of rotary desiccant air conditioning systems have been proposed and studied both analytically and

experimentally [19,51–93]. To provide an overview of the research situation, both the conventional rotary desiccant air conditioning cycles and the recent developed technologies will be described in this section.

3.1. Basic rotary desiccant dehumidification and air conditioning processes

The first patent on rotary desiccant air conditioning cycle was introduced by Pennington in 1955 [52]. Fig. 4 shows the Pennington cycle, also known as ventilation cycle, schematically and psychrometrically. Ambient air at state point 1 is adopted as process air and passes through a desiccant wheel (DW), where its moisture is removed and temperature is increased due to the adsorption heat effect. Then this hot dry air is sensibly cooled from state point 2–3 in a heat exchanger (HE). Whereafter, the process air is evaporatively cooled to supply air state by passing through a direct evaporative cooler (DEC). On the regeneration air side, return air at state point 5 is cooled and humidified in another DEC. This air is then sensibly heat exchanged with the process air to precool the process air and pre-heat itself. The warm air stream is then further heated from state point 7–8 by the heat source (HS). After regenerating the DW, the air is exhausted at state point 9.

Since the building exhaust of room air is not centralized or is not located in a convenient location for co-processing of ambient air for some applications, a modified ventilation cycle (Fig. 5), which also processes ambient air to the building, but uses ambient air for regeneration, is proposed. It is obvious that, the thermal performances including thermal coefficient of performance (COP) and specific cooling capacity would be reduced in comparison with standard ventilation cycle due to that both the humidity ratio and temperature of ambient air are usually higher than that of return air.

To elevate the cooling capacity, recirculation cycle, which is a variation of Pennington cycle and reuses return air as process air, is developed. As depicted in Fig. 6, ambient air is used for regeneration in this cycle. Due to the humidity ratio and

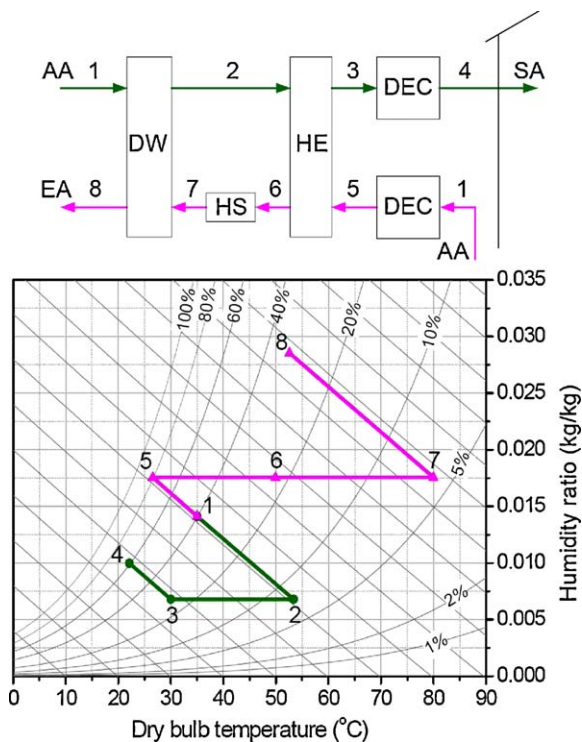

Fig. 5. Modified ventilation cycle.

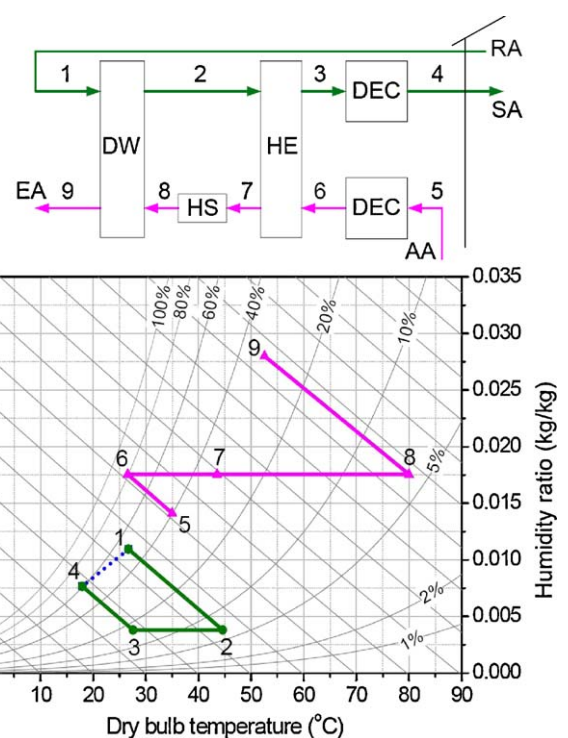

Fig. 6. Recirculation cycle.

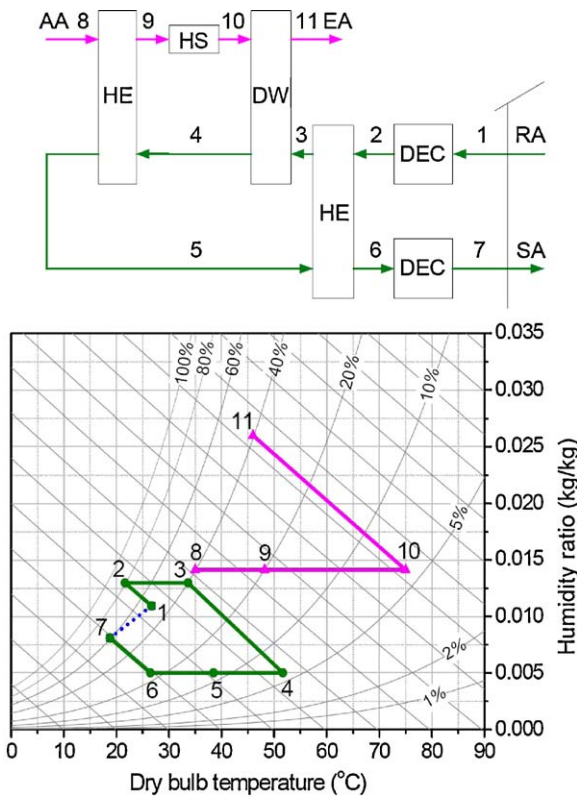

Fig. 7. Dunkle cycle.

temperature are relatively low, the thermal COP of this cycle is commonly no more than 0.8 [19]. The main disadvantage of recirculation cycle is lacking in fresh air.

Dunkle cycle [53] combines the merits of ventilation cycle, which can provide cold air with relative low-temperature for the HE, and recirculation cycle, which can provide the conditioned space with relative large amount of cooling capacity. As seen in Fig. 7, an extra heat exchanger is incorporated. Like recirculation cycle, Dunkle cycle is also limited by the lack of fresh air.

It is obvious that fresh air not only means comfort and health but also represents an additional load. Furthermore, many cooling loads do not require that outdoor air be the source of system. Hence, fresh air should be maintained at the required level to ensure both favorable system performance and good indoor air quality. In view of this, Maclaine-cross [54] proposed a simplified advanced solid desiccant cycle, namely, SENS cycle. Fig. 8(a) illustrates the schematic of the SENS cycle. As seen, ambient air is first dehumidified in a DW. Then the air is sensibly cooled in two HEs in tandem. Afterwards, it is mixed with certain amount of return air and cooled further in a cooling coil (CC) by exchanging heat with cold water from a cooling tower (CT). Then the air stream is divided into two parts. While one part is redirected to the CT and exhausted after exchanging heat with the process air in a HE, the other part is supplied to the conditioned space. On the regeneration side, ambient air is pre-heated in a HE. It is then heated by HS, drawn through the DW and exhausted back to the outdoors. Mathematical modeling predicted that the SENS cycle can achieve a thermal COP above 2.0. Moreover, testing at the Solar Energy Applications Laboratory at Colorado State University [19] demonstrated that the thermal COP of this cycle was about 2.45 under ambient conditions of 26 °C and 26% RH. However, this cycle is blocked by its complexity. REVERS cycle [55] is a simplified version of SENS cycle with the only change of removing a HE, as shown in Fig. 8(b).

Fig. 9 depicts the direct-indirect evaporative cooling (DINC) cycle proposed by researchers in Texas A&M University [56].

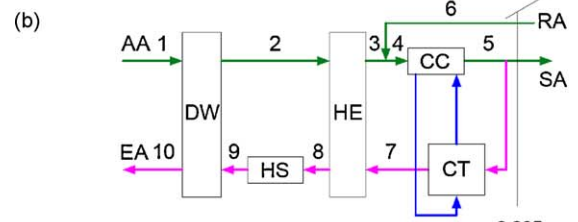
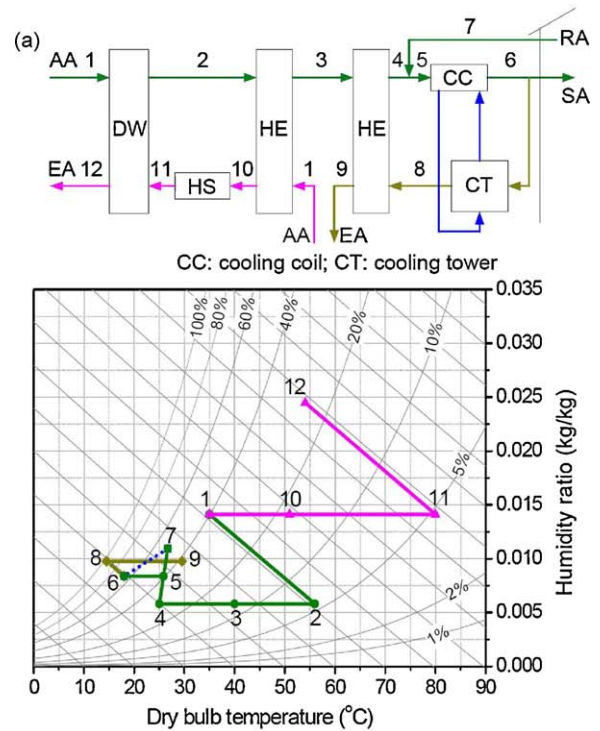

Fig. 8. (a) SENS cycle and (b) REVERS cycle.

Differently from REVERS cycle, the CC and CT are replaced by an indirect evaporative cooler (IEC) and a DEC. This change simplifies the system configuration further. In addition, only an IEC is added in comparison with modified ventilation cycle. As Waugaman [56] predicted, the thermal COP of DINC cycle could be over 1.6 under ARI conditions.

3.2. Staged regeneration

To improve the thermal performance of rotary desiccant air conditioning systems, staged regeneration, which was proposed and patented by Glav in 1966 [57], has been reintroduced [58–61]

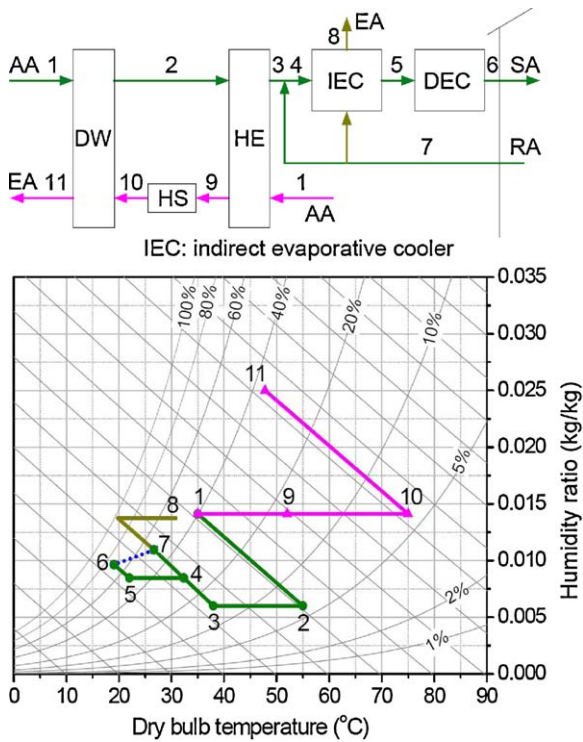

Fig. 9. DINC cycle.

for desiccant regeneration. As illustrated in Fig. 10, after being pre-heated in the HE (from state point 6–7), only a fraction of the regeneration air is heated by the HS (from state point 7–8), while most of the regeneration air is introduced to the pre-regeneration

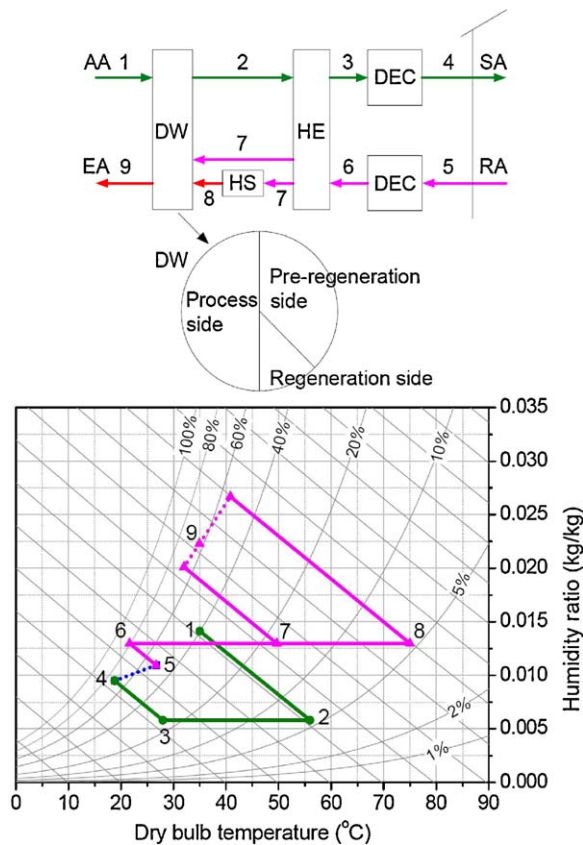

Fig. 10. Staged regeneration cycle.

area directly. Obviously, the regeneration process includes two stages, namely, 1st stage regeneration in the pre-regeneration side with relative low-temperature and without additional heating, and 2ed stage regeneration in the regeneration side with desired high temperature provided by an additional HS. Basically, the desiccant is first pre-heated and pre-regenerated with low-temperature heat, and then is further regenerated with a much smaller amount of high-temperature heat.

Collier and Cohen [58] compared the effect of staged regeneration on improving the thermal COP of desiccant systems with that of the addition of inert heat capacity to the desiccant matrix. It was found that, although both of the two methods increased thermal COP by sacrificing cooling capacity, staged regeneration combined with low heat capacity was superior to adding inert heat capacity to the desiccant matrix in elevating system performance. As suggested by the authors, the best system performance would be obtained by staging the regeneration process while minimizing the amount of inert heat capacity. Worek et al. [59] have reported that high performance for a ventilation cycle could be achieved by using Type 1M material regenerated at 165 °C, with a staged regeneration fraction of 16%. Moreover, staged regeneration is advantageous in not only reducing the size of HE, and thus reducing system size and cost, but also lowering the requirement of effectiveness of HE without extra loss in performance.

3.3. Isothermal dehumidification

Due to the effect of adsorption heat released during the dehumidification process, the temperature of the process air is increased and its relative humidity is decreased. As a result, the vapor difference, which is actually the driving force for dehumidification, is reduced, and corresponding dehumidification ability is limited then. Because of this, much higher regeneration temperature is required to obtain desired dehumidification capacity, especially for high humid climates. To combat this problem, isothermal dehumidification is of great importance, since it can minimize the irreversibility of dehumidification and cool the process air sufficiently [12,13,62–66]. The basic idea is as follows: when the air flows alternatively over infinite desiccant wheels and inter-coolers, its thermodynamics procedure would be close to isothermal. Fig. 11 shows psychrometrically the air treatment process of an ideal multi-stage system in comparison with a one-stage system. With other conditions unchanged, the regeneration temperature of an ideal infinite multi-stage desiccant cooling system would be the minimum and the consumption of regeneration heat would be

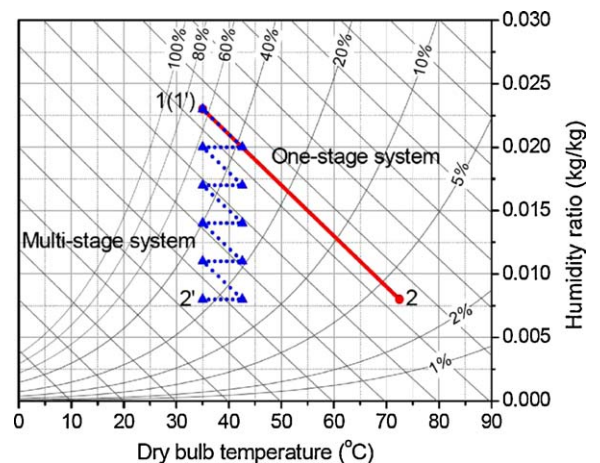

Fig. 11. Comparison between one-stage and multi-stage system in psychrometric chart.

reduced for the heat recovery measures via adopting intercoolers. Therefore, both the thermal performance and applicability would be improved significantly.

Meckler [62] has proposed a two-stage solid desiccant air conditioning system integrating with a HVAC system. An enthalpy exchanger is employed to pre-cool and pre-dehumidify the process air by exchanging sensible and latent heat with return air from conditioned space without addition of external heat or regeneration. Afterwards, conventional desiccant wheel is used to dehumidify the air further with external heat. As reported, 30–50% of the dehumidification task could be accomplished by the enthalpy exchanger. This kind of two-stage system has also been introduced by Henning [63]. Besides, Gershon Meckler Associates, P.C. (GMAPC) [64] has developed a two-stage desiccant unit for fast-food restaurants. In the unit, two desiccant wheels, two heat-pipe exchangers, two direct-gas heaters, two heat recovery wheels and two evaporative coolers are arranged alternatively. The regeneration air streams are first cooled in the evaporative coolers and then pass through the heat recovery wheels to adsorb heat transferred from the process airs. Behind the heat recovery wheels, the airstreams are heated by the heat-pipe heat exchangers, which transfer heat from regeneration airs exiting the desiccant wheels, and the direct-fired gas heaters in tandem. The heated air streams then pass through the desiccant wheels and reactivated the desiccant. Under design conditions, the thermal COP of this two-stage system was 0.89. It was demonstrated that the annual electric energy use and energy cost by the desiccant unit were 60% and 40% less than that of the VAC unit, respectively. Moreover, Zhang and Niu [65] have discussed the use of low regeneration temperature in a two-stage desiccant cooling system. Simulation results showed that lower regeneration temperature was required than for a single-stage desiccant cooling system.

Lately, researchers in Shanghai Jiao Tong University (SJTU) [12,13] have successively developed two types of two-stage system, namely, two-stage rotary desiccant cooling (TSDC) system using two desiccant wheels and one-rotor two-stage rotary desiccant cooling (OTSDC) system based on one wheel, as depicted in Figs. 13 and 14. The main difference lies in the division of the cross-section of the wheel. As seen in Fig. 12, while the cross-section of the TSDC system is of the same as conventional desiccant wheel with one-stage dehumidification process, of which the cross-section is divided into two parts: one for process air and the other for regeneration air, the cross-section of the OTSDC system is divided into four parts: two for process air and two for regeneration air. Newly developed silica gel-lithium chloride-based composite desiccant, with relative better moisture removing capacity and lower regeneration temperature requirement, has been utilized. Besides, internal coolers have been incorporated to achieve further improvement in system performance. It has been found that both of the two systems can be driven by heat sources above 50 °C and achieve favorable thermal COP over 1.0. As reported by Ge et al. [12], for the TSDC system, the required temperature for reaching a moisture removal about 6 g/kg was decreased from 100 °C to 70 °C in comparison with conventional one-stage system under ARI summer condition. In addition, the

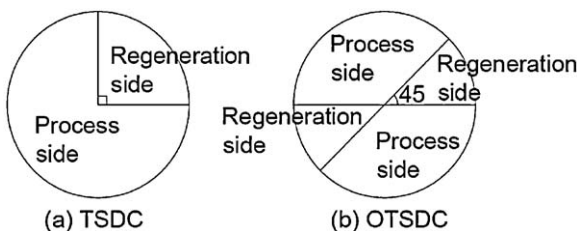

Fig. 12. Schematic of cross-sections: (a) TSDC and (b) OTSDC [13].

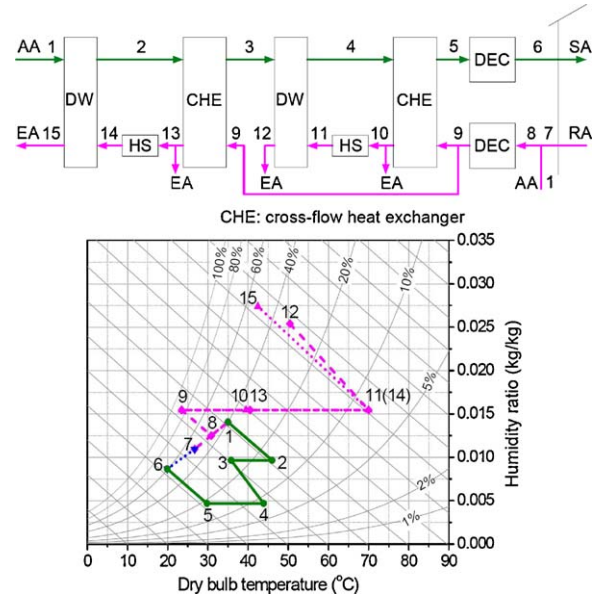

Fig. 13. Two-stage desiccant cooling system.

OTSDC system reduced size by about half in comparison with the earlier developed TSDC system, which would be of great benefit to the promotion of rotary desiccant air conditioning system in residential buildings. The air treatment process of the OTSDC system is similar to that of the TSDC system in tendency, and thus its psychrometric chart would not be illustrated here.

3.4. Hybrid desiccant air conditioning systems

Notice that, desiccant cooling systems described above handle sensible heat load via over-drying the process air to permit its further cooling by direct or indirect evaporative cooling. In the case of hot and humid climates, the cooling capacity of these systems would be limited due to the possible dehumidification may be not high enough to enable evaporative cooling of the supply air [63]. To output qualified supply air, other air conditioning technologies, such as traditional VAC unit and absorption cooling machine, should be incorporated to constitute hybrid system. Fig. 15 illustrates a typical hybrid desiccant air conditioning system schematically and psychrometrically [67]. As can be seen, the latent heat load and sensible heat load are removed by the desiccant wheel and evaporator, respectively. On the regeneration

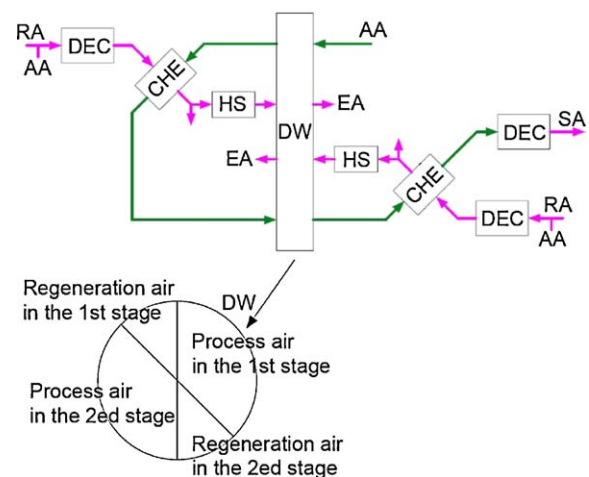

Fig. 14. One rotor two-stage desiccant cooling system.

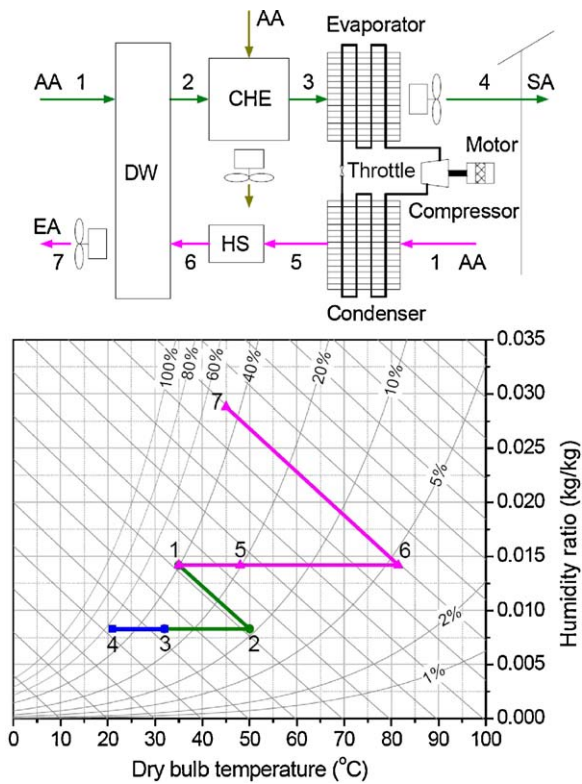

Fig. 15. Hybrid desiccant cooling system [67].

side, the airstream is first pre-heated through recovering heat from the condenser before being heated by the heat source. Advantages of this combination are as follows: (1) improved indoor air quality for the independent control of temperature and humidity ratio; (2) lower regeneration temperature than that of desiccant-only system due to less moisture is required to be removed by the desiccant wheel; (3) substantial overall energy conservation since the condenser providing most of the regeneration heat; (4) downsized VAC unit for handling only sensible heat load; (5) improved performance of VAC unit due to operation at higher evaporation temperature.

A great many theoretical investigations on hybrid desiccant air conditioning system have been carried out [19,68–77,79–85]. Corresponding research activities are mainly as follows.

3.4.1. Hybrid desiccant and VAC unit

Most of existing R&D works on hybrid desiccant systems are of this kind. Burns et al. [68] have studied the performance of three possible hybrid system configurations in supermarket applications and have compared their performance with traditional VAC system on the basis of the concept of weighted energy consumption, with one unit of electrical energy weighted twice that of thermal energy. As reported, a total air conditioning saving ranging from 56.5% to 66% could be achieved for specified design conditions (ambient conditions: 30 °C, 16 g/kg da; indoor conditions: 24 °C, 10.4 g/kg; room sensible heat ratio: 0.35). Also, Dhar and Singh [69] have evaluated the performance of four hybrid cycles, which included a new proposed cycle and the cycles proposed by Burns et al. [68], for typical hot-dry and hot-humid weather conditions, using the analogy method of Maclaine-Cross and Banks [70]. The effects of room sensible heat factor, ventilation mixing ratio, and regeneration temperature have been studied. It was found that solid desiccant-based hybrid air conditioning systems gave substantial energy savings in comparison with conventional vapor compression refrigeration-based air conditioning systems in most commonly

encountered situations. Besides, Sheridan and Mitchell [71] have analyzed the performance of a hybrid desiccant cooling system for hot-humid and hot-dry climates. The results showed that the energy savings ranged from 20% to 40% in high sensible heat load applications and the hybrid system saved more energy in a hot-dry climate than that in a hot-humid climate, where it might even use more energy than a conventional system. Maclaine-Cross [72] has investigated the feasibility of gas-fired hybrid desiccant cooling systems for medium to large general air conditioning projects. The desiccant unit, which consists of a regenerative dehumidifier, heat exchanger, evaporative cooler, heating coil and fans, handles the fresh air, latent and part of the sensible heat load. The remaining sensible heat load is removed by a gas engine driven VAC plant. Analysis results suggested that half of the energy costs could be saved for Australian conditions, if the waste heat was recovered to fire the desiccant unit. Worek and Moon [73] have modeled the performance of a desiccant integrated hybrid VAC system. The waste heat rejected from a VAC cycle is utilized to activate a solid desiccant dehumidification cycle directly. The performance sensitivity of a first generation prototype hybrid VAC system to variable outdoor conditions has been studied and compared to the performance of conventional VAC systems. Results showed that the performance improvement over VAC systems could be 60% at the same level of dehumidification under ARI summer conditions. Capozzoli et al. [74] presented a case study by comparing a traditional HVAC system to hybrid systems with chemical dehumidification for supermarket applications. It uses the dynamic simulation codes (DOE and DesiCalc™) and test reference year data (TRY). Based on annual operating costs estimation, large savings were obtained with hybrid systems. Besides, considerable reduction of electric energy demand and better control of thermal-hygrometric conditions were noted. These resulted in a simple payback of about 1 year. Furthermore, a virtual retrofitting operation on 30% of the existing HVAC systems in Italian supermarkets showed significant operating cost savings. Elsayed et al. [75] have evaluated and examined the feasibility and performance of air cycle refrigerator driving air conditioning system integrated desiccant system. The results indicated that the system performance, which increased with the outdoor air ratio, highly depended on the ratio of the amount of outdoor intake air to the supply air. It was also suggested that the system had a potential to become a good alternative for the conventional VAC system with low environmental load, especially for applications need high outdoor air ratio and a precise control of indoor humidity. Moreover, Mazzei et al. [4] have reviewed the moisture control in buildings. Various possible AHU configurations were examined and HVAC systems for a theatre and for a supermarket were analyzed. Compared with the traditional VAC system, following advantages of hybrid systems have been summarized: remarkable savings in operating costs and higher plant costs (a simple payback time of 2–3 years for supermarket), notable reduction of power electric demand and better control of ambient humidity. Ghali [76] have simulated the transient performance of a hybrid desiccant VAC system for the ambient conditions of Beirut. The annual energy consumption of the hybrid system in comparison with the conventional VAC system has been studied for the entire cooling season. A pay back period less than five years was achieved. Turner et al. [77] have carried out some investigations on heat pump desiccant wheel systems driven by internal combustion engine. Part of the regeneration energy is supplied by the engine exhaust heat. Predicted results showed that much favorable energy saving potential could be achieved in comparison with all-electric pump at several different US climates.

3.4.2. Hybrid desiccant and absorption chiller

Due to both of the two integrated technologies are thermally powered, the hybrid system can be operated with only a small

amount of eclectic power consumption. Furthermore, this integration is suitable for cascaded utilization of energy, since absorption systems usually need to be driven with higher temperature heat (single-effect: 80–100 °C, thermal COP 0.7; double-effect: 140–160 °C, thermal COP 1.1–1.2 [63]) than that of desiccant systems (50–80 °C, thermal COP above 1.0 [78]) and the exhaust heat from absorption systems can be reused by desiccant systems. Hence, much more energy can be saved. However, the temperature requirement of heat source will also be increased, so that the performance of absorption systems can be ensured. Schinner and Radermacher [79] have combined an air desiccant system with a single-stage ammonia-water absorption system to develop a triple-effect system. It is advantageous in using off-the-shelf components. Four cases have been analyzed to determine the optimum operating conditions of the desiccant/absorption system. It was predicted that the most efficient use of the system would result using outdoor air as the process air and return air for the regeneration. To ensure operation near its optimum efficiency, the combined system needed to be integrated with the control scheme of the overall HVAC system.

3.4.3. Hybrid desiccant and adsorption chiller

Like absorption systems, adsorption systems are also driven by thermal energy. However, the required temperature grade is much lower (60–85 °C, thermal COP 0.3–0.5 [78]). Dai et al. [80] have proposed a hybrid solar cooling system for cooling grain. In this system, a rotary desiccant wheel is used for dehumidification, while a solar adsorption collector acts as both an adsorption unit and a solar collector. The special design, with the solar adsorption collector placed on the roof of the grain depot, reduced the heating load from sunshine to a greater extent. Analysis results demonstrated that the new hybrid system performed better than the solid adsorption refrigeration system alone. Under typical conditions, the thermal COP of the system was above 0.4 and the outlet temperature was below 20 °C.

3.4.4. Hybrid desiccant and chilled-ceiling

This method utilizes the advantages of chilled-ceiling, such as lower indoor temperature difference and higher evaporative temperature in comparison with traditional HVAC system, which lead to more comfortable indoor environment and better system performance. Besides, the integrated desiccant system can meet the latent heat load of conditioned space and prevent chilled-ceiling from surface condensation. Zhang and Niu [81–85] have done a series of researches on chilled-ceiling-based hybrid desiccant air conditioning system. The results indicated that chilled-ceiling combined with desiccant cooling saved significantly amount of primary energy consumption, in comparison with a conventional constant volume all-air system. Besides, majority of annual operating hours for desiccant regeneration could be accomplished by low grade heat of less than 80 °C with the new cycle. It was found that dehumidification and ventilation prior to cooling panels operation was required to reduce condensation risks in hot and humid climates, and 1-h in advance dehumidification/ventilation in summer could completely eliminate the condensation problems.

Additionally, some experimental researches have also been reported [67,86–89]. Subramanyam et al. [86,87] studied a desiccant wheel integrated air-conditioner for low humidity air conditioning. It works similar to recirculation mode, with the return air passing through the regeneration section, evaporator and dehumidification section in tandem. While the desiccant wheel dehumidifies and heats the supply air, the regeneration of desiccant is accomplished by the return air, which gets cooled and humidified, without additional heat source. Compared with the conventional reheat system, the system delivered supply air at

much lower dew point temperature with a marginal penalty on COP. It was suggested that an optimum wheel speed of about 17.5 rph existed at which both moisture removal capacity and COP were maximum. Li et al. [67] have experimentally studied a hybrid desiccant dehumidification air conditioning system, which adopted LiCl desiccant wheel, at typical operative ranges for air conditioning applications, particularly for high humid regions like Hong Kong. Experimental results showed that the latent heat was removed by desiccant wheel, while the sensible heat was effectively handled by an indirect evaporative cooler and conventional air conditioner. The regeneration temperature as well as process air flow rate had a significant role on the system performance. Moreover, the hybrid system achieved a higher part load performance, and hence assured its effective operation all year around in hot humid regions. Jia et al. [88] have carried out experiments on a hybrid desiccant air conditioning system. It was found that, 37.5% electricity powers was economized compared with the conventional VAC system at inlet conditions of 30 °C and 55% RH. By establishing the thermodynamic model of the hybrid desiccant system with R-22 as the refrigerant, the impact of operating parameters on the sensible heat ratio of the evaporator and the electric power saving rate have been analyzed. As reported, a majority of evaporators could operate in the dry condition even if the regeneration temperature was lower (i.e. 80 °C). Khalid et al. [89] have performed experimental and simulation studies on a solar assisted pre-cooled hybrid desiccant cooling system for air conditioning applications in Pakistan. A gas fired pre-cooled hybrid desiccant cooling setup has been built to carry out the tests and a validated TRNSYS model of the same cooling system has been founded to simulated its solar performance. Simulation results demonstrated that better COP could be achieved using indirect evaporative cooler for pre-cooling and direct evaporative cooler for post-cooling of air. Based on the life cycle and economic assessments of solar air collector, energy and environmental payback periods were found to be 1 and 1.5 years, respectively.

3.5. Desiccant air conditioning system producing both dry air and chilled water

Considering that, for the purpose of removing the released adsorption heat in dehumidification process, existing desiccant air conditioning systems either combines desiccant dehumidification with direct/indirect evaporative cooling (desiccant-only system), which would be difficult to control accurately, or incorporates conventional VAC unit as auxiliary cooler (hybrid system), which still consumes certain quantity of electric power, an innovative system based on the technologies of two-stage rotary desiccant dehumidification and regenerative evaporative cooling has been proposed and investigated most recently by the authors [90,91]. Fig. 16 illustrates the schematic diagram and psychrometric chart of the system. As seen, the unit generally consists of two parts, namely, desiccant dehumidification and regenerative evaporative cooling. Here, a one-rotor two-stage desiccant dehumidifier with internal coolers is employed to minimize the adsorption heat, approach the isothermal dehumidification and obtain deep dehumidification. Different from the developed wet-surface heat exchanger-based systems [92–94], this system can simultaneously dehumidify the fresh process air and produce chilled water for space cooling due to the deep dehumidification and pre-cooling design before the procedure of evaporative cooling. According to the results of thermodynamics analysis and energy saving potential evaluation, the system achieved a thermal COP about 1.0 and electric COP up to 9.03 under ARI summer condition. Corresponding power consumption and CO₂ emission were decreased by 72.69% in comparison with VAC system. Furthermore, by changing the ratio of dry air, the cooling capacity for

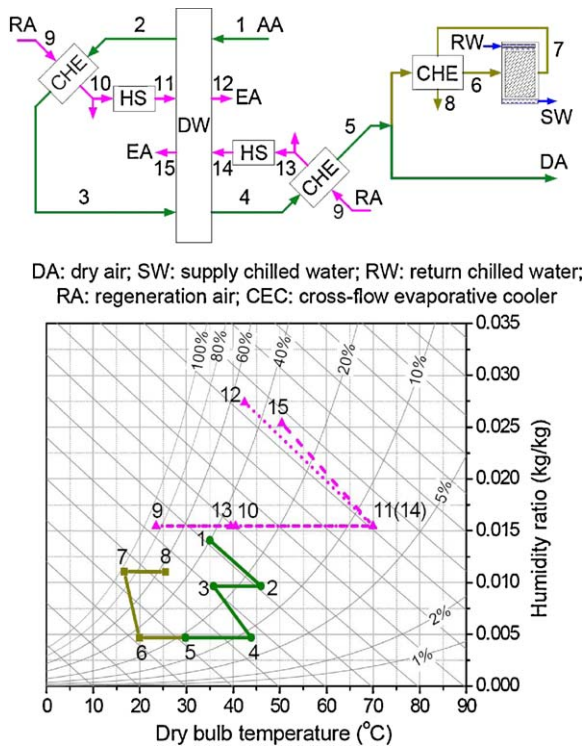

Fig. 16. Desiccant cooling system producing both dry air and chilled water.

handling latent and sensible heat loads could be adjusted, thereby realizing the purpose of affording cooling power without energy waste. Since the system works on thermal energy and realizes the independent temperature and humidity control just using free water and air without any assistance from traditional VAC unit, it would be more environmental friendly.

4. Recent application

The industry market of rotary desiccant dehumidification has been well-developed since the 1980s [1]. Corresponding rotary desiccant air conditioning system has also been experiencing an aggressive commercial application increase for several decades. With the more than half a century R&D in rotary desiccant dehumidification for comfort control as well as the increase of occupant comfort demands and deterioration of global energy and environment crisis, more and more commercial and building owners have been willing to invest in dehumidification equipment [95,96]. Hence, favorable market prospect can be expected. Due to the largest energy expenditure in a desiccant system is the heat used to reactive the desiccant, according to the heat source coupled with, rotary desiccant air conditioning systems can be generally classified into two categories in practical application, namely, solar-powered rotary desiccant air conditioning system and rotary desiccant air conditioning system powered by other low grade heat sources, such as district heating, heat supplied from a combined heat and power (CHP) plant, waste heat and bioenergy. In this section, several representative installed systems will be briefly described to show an overview of recent application status.

4.1. Solar driven rotary desiccant air conditioning systems

Since the required temperature for an efficient regeneration of desiccant wheel is low, within the range of 45–90 °C [97], solar thermal system, which is advantageous in matching the cooling demand profile perfectly, is expected to provide a substantial part



Fig. 17. Solar desiccant cooling system installed in Riesa, Germany [111].

of the energy needed for air conditioning. These have sparked growing interest in coupling rotary desiccant air conditioning and solar energy up. A lot of theoretical analysis-based researches have been performed [80,89,98–110] and some pilot projects have been implemented too [16,63,111–121].

Fig. 17 shows the solar assisted desiccant cooling system installed at a technology center in Riesa/Saxony, Germany [16,111]. A 330 m³ conference room is air conditioned with a nominal air volume flow of 2700 m³/h. A flat plate collector system of 20 m² with a 2 m³ hot water buffer storage tank is employed to drive the system. According to the outdoor conditions and cooling/heating load, five operation modes of the system are possible, namely, active heating, heat recovery, free ventilation, adiabatic cooling and desiccant cooling (ventilation cycle). Besides, the ventilators of the system can be controlled to get variable flow rates to match the cooling load. Operating experience indicated that the system was operable with regeneration temperatures ranging between 50 °C and 70 °C. Results from measurements

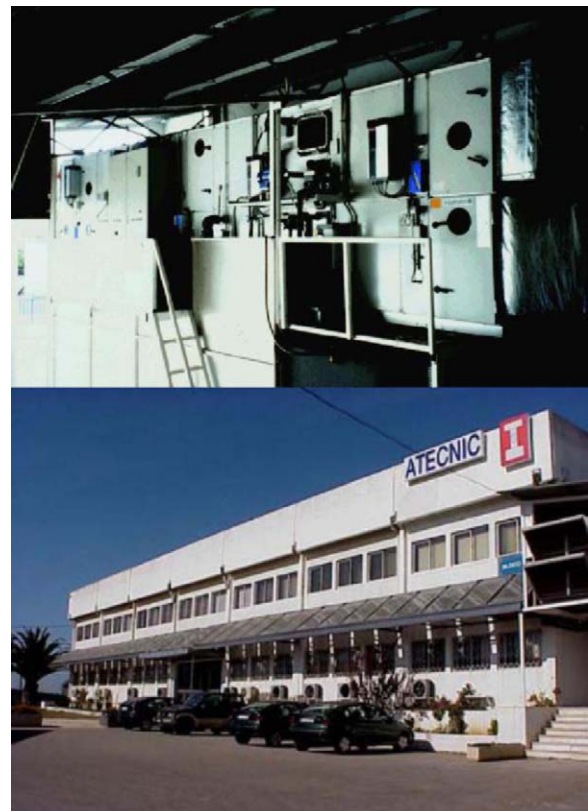

Fig. 18. Solar desiccant cooling system installed in Sintra, Portugal [111,112].

showed that the system could achieve a maximum cooling output about 18 kW, a solar fraction for cooling in the range of 76% and a thermal COP in the range of 0.6.

Funded by the EU's THERMIE-program, ATECNIC, a manufacturer of air conditioning equipment, installed a solar desiccant air conditioning system in Sintra, Portugal [111–113]. Fig. 18 shows the conditioned building, and the installed desiccant unit and collector array. A heat recovery wheel and a nozzle type humidifier are employed to pre-cool and humidify the process air. Also, a humidifier is adopted on the regeneration side for humidifying the return air. Being powered by the 75 m² compound parabolic collectors, connected to a 3 m³ buffer tank with plate heat exchanger, the desiccant cooling unit works with variable airflow, up to a maximum of 9600 m³/h, with a maximum cooling power of 75 kW and a maximum electric load of 15 kW. Thermal COP of this system was 0.78 at design conditions and expected solar fractions for cooling and heating were all 70%.

A solar desiccant cooling system equipped with flat plate solar collectors of 22.5 m² and coupled with a radiant ceiling of 76.1 m² has been installed at University of Palermo, Italy, as shown in Fig. 19 [114]. A hot water tank and an auxiliary boiler are employed. Also, a back-up water-to-air chiller is integrated into the air treatment process. Two cooling coils are placed before and after the desiccant wheel to pre-cool and pre-dehumidify the process air, and control the air temperature when the heat recovery cooling (indirect evaporative cooling) is not sufficient for this task. Part of the rejected heat is delivered to the air stream for the regeneration of the desiccant wheel by placing a condensing coil on the regeneration side. Generally, while the radiant ceiling is designed to meet the sensible load in case of moderate people occupation of the rooms, the solar desiccant cooling unit will meet latent and part of the sensible load in case of higher occupation patterns. This solar desiccant air conditioning system covered a peak summer load for 28.8 kW with an expected thermal COP of 0.86.

In Orbassano, Italy, a hybrid photovoltaic (PV)/thermal collector-based solar desiccant cooling system has been

implemented recently [115,116]. As illustrated in Fig. 20, the system consists of hybrid PV-thermal collectors, a gas powered CHP trigeneration system, a reversible heat pump and a desiccant wheel dehumidification plant, connected to the electric grid and the air conditioning plant of the building. It has been developed on the basic idea of removing the waste heat from photovoltaic cells for its successive utilization through the convective airflow behind the PV panels. While the photovoltaic elements produces electric energy, which is used to feed a heat pump and internal electrical requirements, the forced air circulation beneath the modules cools the cells and recovers the thermal fraction of captured solar radiation, which is used to condition the kitchen. As reported, the system operated as follows: during all the year, the PV and the cogeneration plants fed the heat pump and the internal electric loads; in summer, the heat recovered from the hybrid facade and the cogenerator was used for dehumidifying the renewal air, while the heat pump was employed for cooling application; in winter, the heat generated from both the facade and cogenerator was used for heating.

Besides, five pilot rotary desiccant cooling systems, which are within Task 25 on "Solar Assisted Air Conditioning of Buildings" in the Solar Heating & Cooling Programme of the International Energy Agency, have been installed and monitored in Freiburg/Germany, Hartberg/Austria, Mataro/Spain, Lisbon/Portugal and Waalwijk/Netherlands, respectively [117–119]. Corresponding design values of cooling capacity are, respectively, 50 kW, 30 kW, 55 kW, 36 kW and 22 kW. The plant installed in Freiburg (Fig. 21) has been designed as a solar autonomous system, which is powered by a standalone solar air collector system of 100 m² without any



Fig. 19. Solar desiccant cooling system installed at University of Palermo, Italy [114].

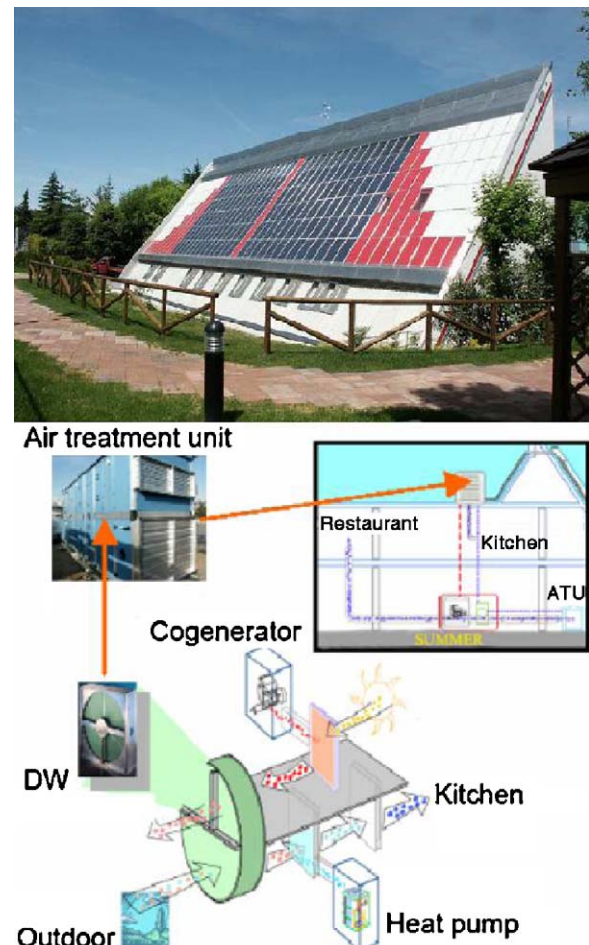

Fig. 20. Solar desiccant cooling system installed in Orbassano, Italy [115].



Fig. 21. Solar desiccant cooling system installed in Freiburg, Germany [117].

back-up heat and thermal storage. Differently, the plant in Hartberg (Fig. 22) is a biomass/solar driven system utilizing 12 m^2 evacuated tube collectors, the desiccant cooling system in Mataro (Fig. 23) is coupled with a combined solar thermal energy system adopting a photovoltaic solar air pre-heating system as well as solar air collectors of 105 m^2 , the system in Lisbon (Fig. 24) is incorporated with a heat pump and assisted by compound parabolic collectors of 51 m^2 , and the installation in Waalwijk (Fig. 25) is driven by a series of flat plate collector of 33 m^2 .

In China, a demonstration solar villa, which integrated the technologies of solar desiccant cooling system, solar hot water system, solar heated swimming pool and sunshade, has been built in Himin Solar Company [120,121]. As shown in Fig. 26, solar air collectors on the roof of building are used to drive desiccant cooling system. The construction area of the building is 300 m^2 . Results of typical run showed that, when the outdoor temperature was $29.3 \text{ }^\circ\text{C}$ and $36.2\% \text{ RH}$, the desiccant cooling unit output air of $20.3 \text{ }^\circ\text{C}$ and $76.2\% \text{ RH}$, which maintained the conditioned rooms at $24.2 \text{ }^\circ\text{C}$ and $54\% \text{ RH}$.



Fig. 22. Solar desiccant cooling system installed in Hartberg, Austria [117].



Fig. 23. Solar desiccant cooling system installed in Mataro, Spain [117].

Moreover, researchers in SJTU have recently designed and installed two newly developed two-stage desiccant cooling systems (principle similar to Figs. 13 and 14, respectively) in Jiangsu and Shanghai, which are all in southeast China and have



Fig. 24. Solar desiccant cooling system installed in Lisbon, Portugal [117].



Fig. 25. Solar desiccant cooling system installed in Waalwijk, Netherlands [119].



Fig. 27. Two-stage solar desiccant cooling system installed in Jiangsu, China.

hot and humid climate in summer. These installations have realized deep dehumidification without high regeneration temperature and big initial investment in solar collectors. Fig. 27 shows the solar-powered TSDC system installed in an office building in Jiangsu. Internal coolers are employed to minimize the adsorption heat and approach the isothermal dehumidification. An air-source VAC unit is incorporated to ensure the operating continuity in cloudy and rainy weather. Flat plate solar collectors are also adopted to ensure good integration with building. The system has been put into operation and its performance has been monitored during the summer of 2008. Under typical weather condition, it was found that the solar-powered desiccant cooling unit was energy efficient, achieving an average cooling capacity above 10 kW with corresponding average thermal COP and electric COP over 1.0 and 10, respectively. This suggested that the system could convert more than 40% of the received solar radiation to the capability of air conditioning in sunny days. In addition, over one third of cooling capacity of the hybrid air conditioning system was contributed by solar-powered unit, which then reduced power

consumption by about one fourth in comparison with traditional air-source VAC system alone.

Fig. 28 illustrates the installed OTSDC system at SJTU. An office of 23.2 m² is conditioned. The designed cooling capacity of this system is 5 kW. Solar air collectors of 15 m² are used to produce hot air. In summer, the solar heated air is introduced into the unit to regenerate the desiccant wheel. In winter, the system can work in two different modes, namely, direct solar heating mode and solar heating with desiccant humidification mode. For the former, after the solar collector, the process air is supplied to room directly. For the latter, except being heated in the collector, the process air is further humidified in the desiccant wheel and handled to a more comfort state. Test works on this system have been carrying out since last winter. It is expected that thermal COP about 1 and solar COP about 0.5 can be achieved under cooling mode. Moreover, based on primary tests under heating modes, fresh air above 30 °C could be provided and the solar heating with desiccant

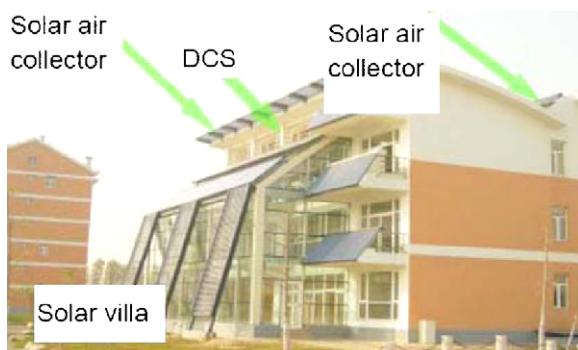

Fig. 26. Solar desiccant cooling system installed in Himin Solar Co., China [120].



Fig. 28. One-rotor two-stage solar desiccant cooling system installed at SJTU, China.

humidification was promising due to the functions of simultaneously heating and humidifying the process air and conditioning the space to a better state.

4.2. Rotary desiccant air conditioning systems powered by other low grade heat sources

As is known to all, solar energy depends on weather conditions and geometrical position greatly and even in area with abundant solar radiation, the performance of solar collector would be poor and could not totally meet the heat requirement of thermal-powered unit in cloudy and rainy weather. For these reasons, most installed desiccant cooling systems are coupled with gas burner, district heating or heat from a CHP plant, etc. [4,15,122–136]. To date, extensive applications have arisen, especially in locations with high moisture production rate or requiring tight control over moisture levels, such as supermarket, ice arena, theater, storehouse and hospital operating room [4,122].

Fig. 29 shows the rotary desiccant cooling system developed by SEMCO Co., USA [127,128]. A direct expansion cooling coil with variable speed compressor and an inverter-driven supply blower are integrated to pre-cooling the process air and control the flow rate of the process air. This system is coupled with total recovery modules and operates as dedicated outdoor air units Sponsored by US Department of Energy, four such systems have been installed at Pepperell High School in Georgia [129]. A natural gas-driven engine generator is adopted to power the systems. Heat recovered from the engine is used to regenerate the desiccant wheels during the cooling season and for heating the supply air during the winter months. As reported, the indoor air quality was improved significantly, contaminants such as formaldehyde were reduced to desired levels, microbial problems were eliminated, and CO₂ level was decreased. Furthermore, by combining an electrical efficiency of 33.4% with a thermal efficiency of 37.2%, an overall system efficiency of 70.5%, far higher than the 45% efficiency typical of a commercial distribution grid, was achieved. Results demonstrated that peak electrical demand at the site was reduced

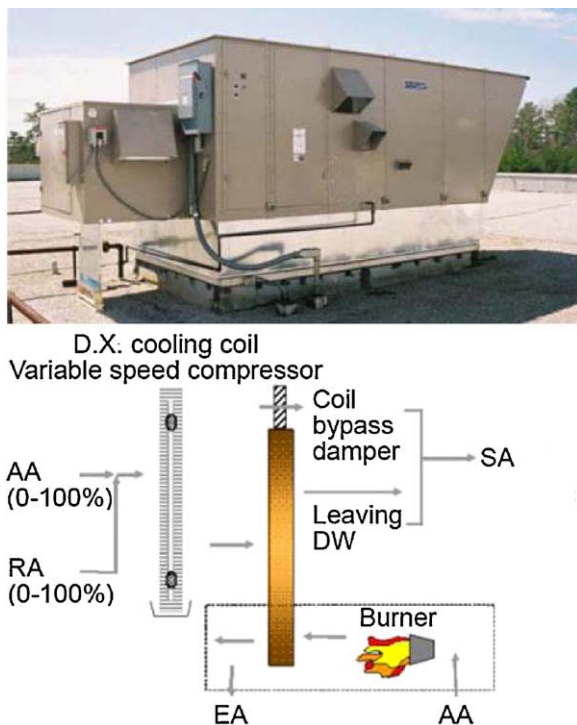

Fig. 29. Desiccant cooling system installed in Georgia, USA [127,128].

by more than 100 kW. Also, approximately 21% cooling and 29% heating season energy costs were reduced.

Researchers in CSIRO (Commonwealth Scientific and Industrial Research Organisation) [130,131] have installed a rotary desiccant cooling system at Hornsby Central Library in Sydney, Australia. As can be seen in Fig. 30, it is a microturbine-based cogeneration system, which can output cooling, heating and power. Powered by natural gas, the microturbine generates certain quantity of electric power, most of which is used as general power for the library. Any excess electricity can be transferred back to the main electricity supply grid and any shortfall will be supplied from the grid. In cooling mode, the heat exhausted by the microturbine is used to drive the desiccant dehumidifier. The cool dry air is then further cooled with either a direct evaporative cooler or with the existing conventional air conditioning plant before being delivered into the library. In heating mode, the exhaust heat is used to indirectly heat the incoming air through a rotary heat exchanger. Test results showed that the utilization rate of natural gas was increased greatly, and thus primary energy consumption was reduced.

Similarly, a hybrid system, which combines a microturbine, a waste heat-driven LiBr/H₂O absorption chiller and a rotary desiccant air conditioning system, has been implemented at a mid Atlantic University [132]. The system has been integrated with the existing electric-powered roof top unit. As illustrated in Fig. 31, the main difference from the unit in Sydney is the adoption of the absorption chiller, which is driven by the exhaust heat from the microturbine and outputs chilled water. The waste heat leaving the chiller is used to power the desiccant unit. The process air is first dehumidified in the desiccant cooling system (DCS) and then sensibly cooled to supply state by exchanging heat with the produced chilled water. Preliminary data indicated the total energy utilization from conversion of natural gas was 78.2%, with a 19% electric conversion efficiency and 59.2% heat utilization efficiency. In addition, the conversion efficiency of waste heat for cooling was 68% in the absorption chiller and 30% in the desiccant unit.

Fig. 32 shows the geothermal energy incorporated demonstration plant for desiccant air conditioning in the building of the ship

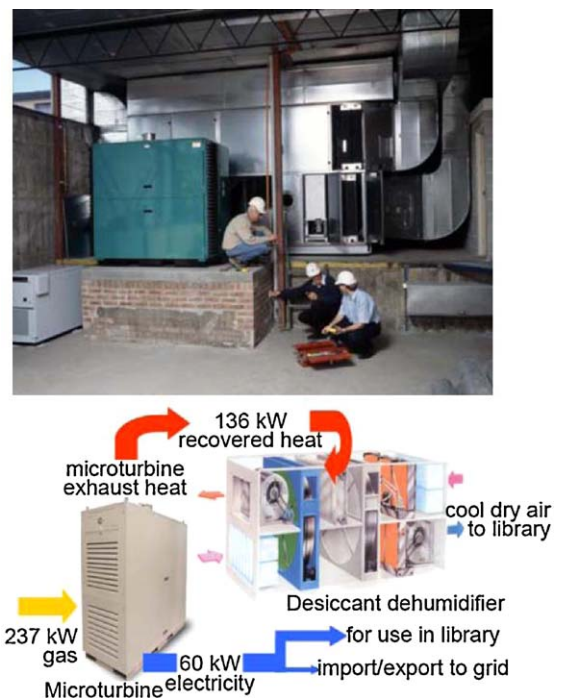

Fig. 30. Desiccant cooling system installed at Hornsby Central Library in Sydney, Australia [130].

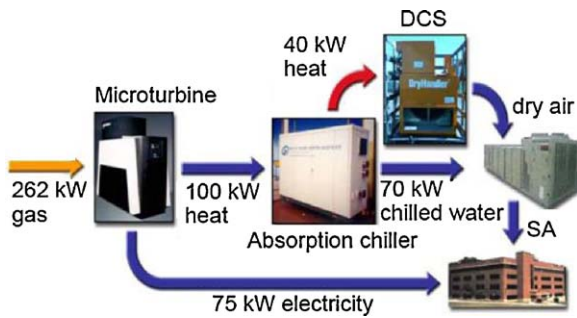

Fig. 31. Desiccant cooling system installed at a mid Atlantic University, USA [132,133].

measurement and control systems company Hoppe Bordmestechnik in Hamburg, Germany [15,134–136]. Borehole heat exchangers (with a nominal cooling capacity of 30 kW) are incorporated to cooperate with the desiccant cooling system and to realize independent temperature and humidity control. Besides, a small CHP-plant (12 kW heat, 5 kW electrical output) and a condensing boiler are employed to feed a storage water tank. In summer, while the desiccant cooling system removes the latent heat load, the borehole system handles the sensible heat load through radiant floor cooling (23 kW) as well as cooling the process air in the desiccant cooling system (7 kW). In winter, the radiant floor is switched to heating mode and fresh air is supplied to the room after being pre-heated in the recovery wheel. Based on this system, 1300 m² office rooms and manufacture halls of in total are

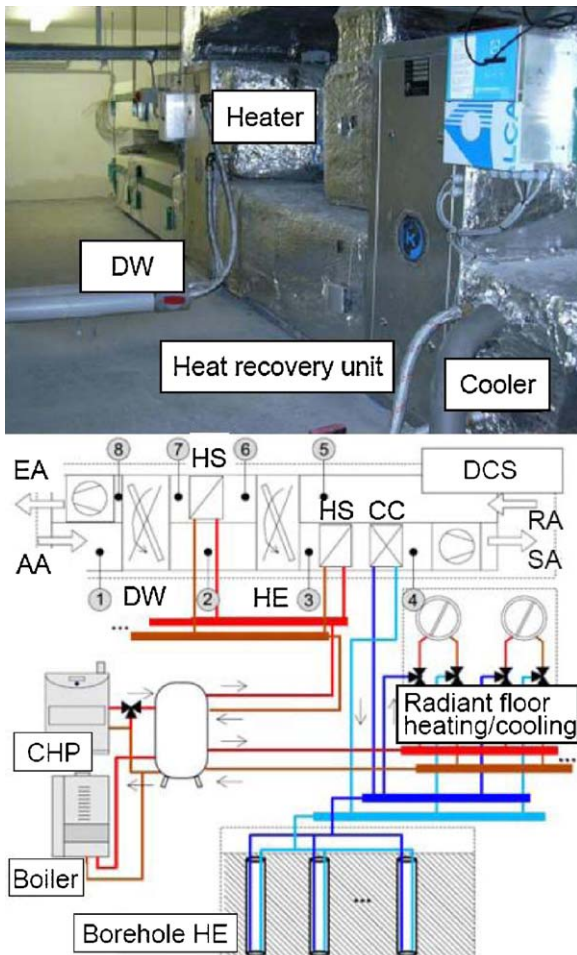

Fig. 32. Desiccant cooling system installed in Hamburg, Germany [15,135].

conditioned. And the designed cooling capacity of the desiccant cooling unit is 7.5 kW at an air flow rate of 2500 m³/h. It was reported that up to 70% primary energy saving was achieved by using desiccant air conditioning with borehole heat exchangers. Compared with conventional air conditioning system, the running costs of the system were reduced drastically, without increasing starting costs.

5. Conclusions and perspectives

Rotary desiccant air conditioning is a typical thermally activated technology, which mainly consumes low grade heat sources as solar energy, district heating, waste heat, etc., thereby alleviating the peak electric demand caused by traditional air conditioning systems. Especially, based on the recent progress in desiccant material and system configuration, more and more practical applications have been implemented around the world. This is a significant stride in comparison with the earlier research works, which were primarily performed on computer analysis [19].

While the most widely used desiccant materials in market, namely silica gel and lithium chloride, are either limited by dehumidification capacity or problematic for crystallization and corrosion, composite desiccants combine the merits of existing desiccants and overcome these problems by confining salt to porous host adsorbent, and have been recognized as a better choice. Additionally, the reduction in regeneration temperature and the increment in dehumidification capacity over a wide range will be of great benefit to utilizing low-temperature heat and expanding the application of desiccant air conditioning.

The majority of existing rotary desiccant air conditioning systems originates from the typical basic configurations, such as ventilation cycle, recirculation cycle and Dunkle cycle. And these cycles are appropriate for different applications, for example, ventilation cycle is recommended for conditioned-space with high outside air requirement, whereas recirculation cycle is suitable to space requiring much less fresh air. Besides, on the basis of the basic system configurations, some advanced technologies, namely, staged regeneration, isothermal dehumidification, hybrid desiccant air conditioning, and desiccant air conditioning producing both dry air and chilled water, have been developed and investigated to lower the reactivation requirement, ensure the operation stability, and improve the thermal utilization rate and energy saving potential. Among these technologies, staged regeneration reduces the consumption of high temperature heat by pre-heating and pre-regenerating the desiccant and is advantageous in reducing the size and effectiveness requirement of heat exchanger; isothermal dehumidification minimizes the irreversibility of dehumidification via adopting multi-stage design and intercoolers, which results in much lower regeneration temperature and less heat consumption; hybrid desiccant air conditioning is most researched due to it integrates the merits of desiccant dehumidification system and other air conditioning systems, downsizes system size and improves system performance significantly; desiccant air conditioning producing both dry air and chilled water is a novel proposed technology using desiccant dehumidification and regenerative evaporative cooling and is worthwhile for future research for its outstanding property of realizing independent temperature and humidity control without any assistance from VAC unit.

Being coupled with solar energy and other low grade heat sources, more and more rotary desiccant air conditioning systems have been installed recently. The traditional niche markets have been expanded greatly from special areas like electronics, food, storage and pharmaceutical, to supermarket, restaurant, school, hospital, office building, etc. [1]. District heating and waste heat-based systems are becoming mature, particularly in the case of CHP

systems being integrated. Renewable energy sources as bioenergy have also been investigated and suggested to be usable. Although solar-powered desiccant cooling is still at the stage of demonstration, it has attracted much more interesting than that powered by any other heat sources due to the advantages of renewability and good match with cooling demand solar energy preserves. Furthermore, when heating and domestic hot water systems are combined, the economic performance would become considerable too.

For the sake of health and comfort, indoor air quality attracts increasing attention, just as the increased levels of outdoor air addressed in ASHRAE standard, which represents increased total cooling load and latent load especially. On the other hand, traditional VAC system only focuses on controlling space dry bulb temperature, whereas space dehumidification is coincidental. Moreover, due to the usage of CFCs and the consumption of a large amount of electric power, traditional VAC system has caused deteriorating energy crisis and environmental pollution. To solve these problems, rotary desiccant air conditioning system is considerable, since its thermally driven, CFCs free and moisture removal characteristics. As recent researches have reduced the capital cost and increased the system performance significantly, rotary desiccant air conditioning system is becoming an alternative to the traditional VAC system. However, to eliminate the obstacles lying between researches and markets, following guidelines are recommended for further research and development:

- (1) Development of high adsorbability, low regeneration temperature and low cost desiccant materials. Composite desiccants as silica gel-lithium chloride can satisfy the requirements of dehumidification and regeneration and shall be a good choice. However, its processing technology is complicated to some degree, which leads to relative high cost.
- (2) Development of staged regeneration or multi-stage dehumidification systems to reduce reactivation temperature requirement and increase thermal utilization rate. Especially, in hot humid climates, for low-temperature regeneration applications, dehumidification demands can barely be met without the adoption of staged regeneration or multi-stage dehumidification. Besides, when solar thermal system is incorporated, the advantages of staged regeneration and multi-stage dehumidification are further represented by low cost solar collector (e.g.: flat plate solar collector and evacuated tube solar collector) and beautiful integration with the building.
- (3) Determination of optimum operating strategies to improve system applicability. Due to the variation of ambient and indoor air states with time, weather, season and location, the thermal and electric performance of the rotary desiccant air conditioning system will be actually determined by the control strategy on operation mode.
- (4) Design of small and compact systems, in order that rotary desiccant air conditioning system can be expanded to the residential buildings, thereby reducing building energy consumption.
- (5) Standardization of production process. Standardized air conditioning design and analysis tools will not only decrease initial cost but also be beneficial to market development.
- (6) Transfer of knowledge of desiccant air conditioning. As a novel technology, rotary desiccant air conditioning has obtained much less recognition by the public and the HVAC professionals even.

In conclusion, further improvement in energy utilization rate, reduction in cost and size, and standardization in design and

production are the key issues faced by the rotary desiccant air conditioning technology for achieving more extensive application.

Acknowledgements

This work was supported by National Key Technologies R&D Program under the contract No. 2006BAA04B03 and the State High Technologies R&D Program under the contract No. 2008AA05Z420.

References

- [1] Wurm J, Kosar D, Clemens T. Solid desiccant technology review. Bulletin of the International Institute of Refrigeration 2002;82(3):2–31.
- [2] Wang RZ. Advances in refrigeration and HVAC. Beijing, China: Science Press; 2007 [in Chinese].
- [3] Zhang XJ. Study on dehumidification performance of silica gel-haloid composite desiccant wheel. PhD Thesis. Shanghai, China: Shanghai Jiao Tong University; 2003 [in Chinese].
- [4] Mazzei P, Minichiello F, Palma D. HVAC dehumidification systems for thermal comfort: a critical review. Applied Thermal Engineering 2005;25(5–6):677–707.
- [5] Nia FE, Paassen D, Saidi MH. Modeling and simulation of desiccant wheel for air conditioning. Energy and Buildings 2006;38(10):1230–9.
- [6] Zhang HF, Yu JD, Liu ZS. The research and development of the key components for desiccant cooling system. Renewable Energy 1996;9(1–4):653–6.
- [7] Ge TS, Li Y, Wang RZ, Dai YJ. A review of the mathematical models for predicting rotary desiccant wheel. Renewable and Sustainable Energy Reviews 2008;12(6):1485–528.
- [8] Shen CM, Worek WM. The second-law analysis of a recirculation cycle desiccant cooling system: cosorption of water vapor and carbon dioxide. Atmospheric Environment 1996;30(9):1429–35.
- [9] Kanoğlu M, Bolattürk A, Altıntop N. Effect of ambient conditions on the first and second law performance of an open desiccant cooling process. Renewable Energy 2007;32(6):931–46.
- [10] Kanolu M, Çarpınlıolu MÖ, Yıldırım M. Energy and exergy analyses of an experimental open-cycle desiccant cooling system. Applied Thermal Engineering 2004;24(5–6):919–32.
- [11] Kabeel AE. Solar powered air conditioning system using rotary honeycomb desiccant wheel. Renewable Energy 2007;32(11):1842–57.
- [12] Ge TS, Li Y, Wang RZ, Dai YJ. Experimental study on a two-stage rotary desiccant cooling system. International Journal of Refrigeration 2009;32(3):498–508.
- [13] Ge TS, Dai YJ, Wang RZ, Li Y. Experimental investigation on a one-rotor two-stage desiccant cooling system. Energy 2008;33(12):1807–15.
- [14] Sand JR, Fischer JC. Active desiccant integration with packaged rooftop HVAC equipment. Applied Thermal Engineering 2005;25(17–18):3138–48.
- [15] Casas W, Schmitz G. Experiences with a gas driven, desiccant assisted air conditioning system with geothermal energy for an office building. Energy and Buildings 2005;37(5):493–501.
- [16] Henning HM, Erpenbeck T, Hindenburg C, Santamaria IS. The potential of solar energy use in desiccant cooling cycles. International Journal of Refrigeration 2001;24(3):220–9.
- [17] Pesaran AA, Penney TR, Czanderna AW. Desiccant cooling: state-of-the-art assessment. National Renewable Energy Laboratory; October 1992, NREL/TP-254-4147.
- [18] Shelpuk B. The technical challenges for solid desiccant cooling. Heat Recovery Systems and CHP 1993;13(4):321–8.
- [19] Waugaman DG, Kini A, Kettleborough CF. A review of desiccant cooling systems. Journal of Energy Resources Technology 1993;115(1):1–8.
- [20] Collier RK. Desiccant properties and their affect on cooling system performance. ASHRAE Transactions 1989;95(1):823–7.
- [21] Collier RK, Cale TS, Lavan Z. Advanced desiccant materials assessment, Final report. Gas Research Institute Report GRI-86/0182; 1986.
- [22] Collier RK. Advanced desiccant materials assessment, phase 2, final report. Gas Research Institute Report GRI-88/0125; 1988.
- [23] Chung TW, Chung CC. Increase in the amount of adsorption on modified silica gel by using neutron flux irradiation. Chemical Engineering Science 1998;53(16):2967–72.
- [24] Knez Z, Novak Z. Adsorption of water vapor on silica, alumina, and their mixed oxide aerogels. Journal of Chemical and Engineering Data 2001;46(4):858–60.
- [25] Yano K, Yoshiaki F. Synthesis of super-microporous aluminosilicate having excellent water vapor adsorption property as an adsorbent for an adsorption heat-pump. Journal of Porous Materials 2003;10(4):223–9.
- [26] Ding J, Yang XX, Su MY, Liang SZ, Tan YK. Study on the principle of adsorption air conditioning system and the additives for enhancing adsorbent properties. Ion Exchange and Adsorption 1998;14(2):166–70 [in Chinese].
- [27] Fang YT, Ding J, Fan J, Yang JP, Yang XX. Preparation and property of a novel Al³⁺-doped silica gel adsorptive material. Journal of South China University of Technology (Natural Science) 2004;32(3):5–10.
- [28] White DA, Bussey RL. Water sorption properties of modified clinoptilolite. Separation and Purification Technology 1997;11(2):137–41.

- [29] Montes HG, Geraud Y. Sorption kinetic of water vapour of MX80 bentonite submitted to different physical–chemical and mechanical conditions. *Colloids and Surfaces A Physicochemical and Engineering Aspects* 2004;235(1–3):17–23.
- [30] Ladisch MR. Biobased adsorbents for drying of gases. *Enzyme and Microbial Technology* 1997;20(3):162–4.
- [31] Beery KE, Ladisch MR. Chemistry and properties of starch based desiccants. *Enzyme and Microbial Technology* 2001;28(7–8):573–81.
- [32] Khedari J, Rawangkul R, Chimchawe W. Feasibility study of using agriculture waste as desiccant for air conditioning system. *Renewable Energy* 2003;28(10):1617–28.
- [33] Zhou L, Wu YG, Liu B, Feng XY, Jiang ZG, Wu CG. Isolation and structural characterization of squid pen β -chitin and its application as bio-desiccant. *Fine Chemicals* 2003;20(1):8–10 [in Chinese].
- [34] Hu M, Xie BJ, Sun J, Zeng J, Yu JX. The removal of the volatiles in konjac feifen and preparation of the konjac dehumidizer. *Fine Chemicals* 2000;17(6):339–42 [in Chinese].
- [35] Aristov Yul. New family of solid sorbents for adsorptive cooling: material scientist approach. *Journal of Engineering Thermophysics* 2007;16(2):63–72.
- [36] Jia CX, Dai YJ, Wu JY, Wang RZ. Experimental comparison of two honey-combed desiccant wheels fabricated with silica gel and composite desiccant material. *Energy Conversion and Management* 2006;47(15–16):2523–34.
- [37] Jia CX, Dai YJ, Wu JY, Wang RZ. Use of compound desiccant to develop high performance desiccant cooling system. *International Journal of Refrigeration* 2007;30(2):345–53.
- [38] Kuma T, Okano H. Active gas adsorbing element and method of manufacturing. USA, Patent No. 4,886,769; 1989.
- [39] Aristov Yul, Tokarev MM, Cacciola G, Restuccia G. Selective water sorbents for multiple applications. 1. CaCl_2 confined in mesopores of silica gel: sorption properties. *Reaction Kinetics and Catalysis Letters* 1996;59(2):325–33.
- [40] Aristov Yul, Tokarev MM, Restuccia G. Selective water sorbents for multiple applications. 2. CaCl_2 confined in micropores of silica gel: sorption properties. *Reaction Kinetics and Catalysis Letters* 1996;59(2):335–42.
- [41] Tokarev MM, Aristov Yul. Selective water sorbents for multiple applications. 4. CaCl_2 confined in silica gel pores: sorption/desorption kinetics. *Reaction Kinetics and Catalysis Letters* 1997;62(1):143–50.
- [42] Gordeeva LG, Restuccia G, Cacciola G, Aristov Yul. Selective water sorbents for multiple applications. 5. LiBr confined in mesopores of silica gel: sorption properties. *Reaction Kinetics and Catalysis Letters* 1998;63(1):81–8.
- [43] Gordeeva LG, Mrowiec-Bialon J, Jarzebski AB, Lachowski AI, Malinowski JJ, Aristov Yul. Selective water sorbents for multiple applications. 8. Sorption properties of CaCl_2 - SiO_2 sol–gel composites. *Reaction Kinetics and Catalysis Letters* 1999;66(1):113–20.
- [44] Tokarev MM, Freni A, Restuccia G, Aristov Yul. Selective water sorbents for multiple applications. 12. Water sorption equilibrium at elevated temperature. *Reaction Kinetics and Catalysis Letters* 2002;76(2):295–301.
- [45] Liu YF, Wang RZ. Pore structure of new composite adsorbent SiO_2 - $x\text{H}_2\text{O}$ - $y\text{CaCl}_2$ with high uptake of water from air. *Science in China Series E* 2003;46(5):551–9.
- [46] Liu YF, Fan HW, Wang RZ. Performances comparison of a new composite adsorbent SiO_2 - $x\text{H}_2\text{O}$ - $y\text{CaCl}_2$ and other common adsorbents to extract water from air. *Acta Energetica Sinica* 2003;24(2):141–4.
- [47] González JC, Molina-Sabio M, Rodríguez-Reinoso F. Sepiolite-based adsorbents as humidity controller. *Applied Clay Science* 2001;20(3):111–8.
- [48] Tokarev M, Gordeeva L, Romannikov V, Glanzev I, Aristov Yul. New composite sorbent CaCl_2 in mesopores for sorption cooling/heating. *International Journal of Thermal Sciences* 2002;41(5):470–4.
- [49] Thoruwa TFN, Johnstone CM, Grant AD, Smith JE. Novel, low cost CaCl_2 based desiccants for solar crop drying applications. *Renewable Energy* 2000;19(4):513–20.
- [50] Mathiowitz E, Jacob JS, Jong YS, Hekal TM, Spano W, Guemonprez R, et al. Novel desiccants based on designed polymeric blends. *Journal of Applied Polymer Science* 2001;80(3):317–27.
- [51] Ghosh TK, Hines AL. Solid desiccant dehumidification systems. *Studies in Surface Science and Catalysis* 1999;120(1):879–916.
- [52] Pennington NA. Humidity changer for air conditioning. USA, Patent No. 2,700,537; 1955.
- [53] Dunkle RV. A method of solar air conditioning. *Mechanical and Chemical Engineering Transactions of the Institute of Engineers* 1965;73:73–8.
- [54] Maclaine-cross IL. A theory of combined heat and mass transfer in regenerations. PhD Thesis. Australia: Monash University; 1974.
- [55] Maclaine-cross IL. High-performance adiabatic desiccant open-cooling cycles. *Journal of Solar Energy Engineering* 1985;107(1):102–4.
- [56] Waugaman DG, Kettleborough CF. Combining direct and indirect evaporative cooling with a rotating desiccant wheel in residential applications. In: *Proceedings of the ASME international thermal and solar energy conference*; 1987.
- [57] Glav BO. Air conditioning apparatus. USA, Patent No. 3,251,402; 1966.
- [58] Collier RK, Cohen BM. An analytical examination of methods for improving the performance of desiccant cooling systems. *Journal of Solar Energy Engineering* 1991;113(3):151–63.
- [59] Worek WM, Zheng W, Belding WA, Novosel D, Holeman WD. Simulation of advanced gas-fired desiccant systems. *ASHRAE Transactions* 1991;97(2):609–14.
- [60] Worek WM, Zheng W. Open cycle desiccant cooling systems. USA, Patent No. 5,526,251; 1996.
- [61] Worek WM, Zheng W. Open cycle desiccant cooling process. USA, Patent No. 5,542,259; 1996.
- [62] Meckler G. Two-stage desiccant dehumidification in commercial building HVAC systems. *ASHRAE Transactions* 1989;95(2):1116–23.
- [63] Henning HM. Solar assisted air conditioning of buildings—an overview. *Applied Thermal Engineering* 2007;27(10):1734–49.
- [64] Mei VC, Chen FC, Lavan Z, Collier RK, Meckler G. An assessment of desiccant cooling and dehumidification technology. OAK Ridge National Laboratory; 1992[available to public from the National Technical Information Service, US Department of Commerce, Springfield, VA].
- [65] Zhang H, Niu JL. Two-stage desiccant cooling system using low-temperature heat. *Building Services Engineering Research and Technology* 1999;20(2):51–5.
- [66] Höfker G, Eicker U, Lomas K, Eppel H. Desiccant cooling with solar energy. <http://www.cibse.org/pdfs/desiccant.pdf>.
- [67] Li Y, Sumathy K, Dai YJ, Zhong JH, Wang RZ. Experimental study on a hybrid desiccant dehumidification and air conditioning system. *Journal of Solar Energy Engineering* 2006;128(1):77–82.
- [68] Burns PR, Mitchell JW, Beckman WA. Hybrid desiccant cooling systems in supermarket applications. *ASHRAE Transactions* 1985;91(Part 1B):457–68.
- [69] Dhar PL, Singh SK. Studies on solid desiccant based hybrid air-conditioning systems. *Applied Thermal Engineering* 2001;21(2):119–34.
- [70] Maclaine-Cross IL, Banks PJ. Coupled heat and mass transfer in regenerators—predictions using an analogy with heat transfer. *International Journal of Heat and Mass Transfer* 1972;15(6):1225–41.
- [71] Sheridan JC, Mitchell JW. A hybrid solar desiccant cooling system. *Solar Energy* 1985;34(2):187–93.
- [72] Maclaine-Cross I. Hybrid desiccant cooling in Australia. *Australian Refrigeration Air Conditioning and Heating* 1987;41(5):16–25.
- [73] Worek WM, Moon CJ. Desiccant integrated hybrid vapor-compression cooling: performance sensitivity to outdoor conditions. *Heat Recovery Systems and CHP* 1988;8(6):489–501.
- [74] Capozzoli A, Mazzei P, Minichiello F, Palma D. Hybrid HVAC systems with chemical dehumidification for supermarket applications. *Applied Thermal Engineering* 2006;26(8–9):795–805.
- [75] Elsayed SS, Hamamoto Y, Akisawa A, Kashiwagi T. Analysis of an air cycle refrigerator driving air conditioning system integrated desiccant system. *International Journal of Refrigeration* 2006;29(2):219–28.
- [76] Ghali K. Energy savings potential of a hybrid desiccant dehumidification air conditioning system in Beirut. *Energy Conversion and Management* 2008;49(11):3387–90.
- [77] Turner RH, Kleiser JD, Chen RF, Chen F. Evaluation of desiccant assisted thermally activated heat pumps in the U.S. climates. *American Society of Mechanical Engineers Advanced Energy Systems Division (Publication) AES* 1988;8:65–71.
- [78] Wang RZ, Ge TS, Chen CJ, Ma Q, Xiong ZQ. Solar sorption cooling systems for residential applications: options and guidelines. *International Journal of Refrigeration* 2009;32(4):638–60.
- [79] Schinner EN, Radermacher R. Performance analysis of a combined desiccant/absorption air-conditioning system. *HVAC&R Research* 1999;5(1):77–84.
- [80] Dai YJ, Wang RZ, Xu YX. Study of a solar powered solid adsorption-desiccant cooling system used for grain storage. *Renewable Energy* 2002;25(3):417–30.
- [81] Niu JL, Zhang LZ. Analysis of energy and humidity performance of a system combining chilled ceiling with desiccant cooling. *ASHRAE Transactions* 2002;108(Part 2):195–201.
- [82] Niu JL, Zhang LZ, Zuo HG. Energy savings potential of chilled-ceiling combined with desiccant cooling in hot and humid climates. *Energy and Buildings* 2002;34(5):487–95.
- [83] Niu JL, Zuo HG, Zhang LZ. Performance of a novel HVAC system in hot and humid weather conditions: chilled-ceiling combined with desiccant cooling. *Transactions Hong Kong Institution of Engineers* 2002;9(2):25–9.
- [84] Zhang LZ, Niu JL. Indoor humidity behaviors associated with decoupled cooling in hot and humid climates. *Building and Environment* 2003;38(1):99–107.
- [85] Zhang LZ, Niu JL. A pre-cooling Munters environmental control desiccant cooling cycle in combination with chilled-ceiling panels. *Energy* 2003;28(3):275–92.
- [86] Subramanyam N, Maiya MP, Murthy SS. Application of desiccant wheel to control humidity in air-conditioning systems. *Applied Thermal Engineering* 2004;24(17–18):2777–88.
- [87] Subramanyam N, Maiya MP, Murthy SS. Parametric studies on a desiccant assisted air-conditioner. *Applied Thermal Engineering* 2004;24(17–18):2679–88.
- [88] Jia CX, Dai YJ, Wu JY, Wang RZ. Analysis on a hybrid desiccant air-conditioning system. *Applied Thermal Engineering* 2006;26(17–18):2393–400.
- [89] Khalid A, Mahmood M, Asif M, Muneer T. Solar assisted, pre-cooled hybrid desiccant cooling system for Pakistan. *Renewable Energy* 2009;34(1):151–7.
- [90] La D, Dai YJ, Li Y, Wang RZ. Study of an innovative solar desiccant cooling system producing both dry air and chilled water. In: *Cryogenics and refrigeration—Proceedings of ICCR'2008*; 2008. p. 628–33.
- [91] La D, Dai YJ, Li Y, Wang RZ. Energy saving potential of a desiccant cooling system producing dry air and chilled water. In: *Proceedings of engineering thermophysics and energy utilization conference of Chinese association of engineering thermophysics*; 2008 [in Chinese].

- [92] Maclaine-Cross IL, Banks PJ. A general theory of wet surface heat exchangers and its application to regenerative evaporative cooling. *Journal of Heat Transfer* 1981;103(3):579–85.
- [93] Hsu ST, Lavan Z, Worek WM. Optimization of wet-surface heat exchangers. *Energy* 1989;14(11):757–70.
- [94] Jain S, Dhar PL, Kaushik SC. Evaluation of solid-desiccant-based evaporative cooling cycles for typical hot and humid climates. *International Journal of Refrigeration* 1995;18(5):287–96.
- [95] Harriman III LG, Judge J. Dehumidification equipment advances. *ASHRAE Journal* 2002;44(8):22–9.
- [96] McGahey K. New commercial applications for desiccant-based cooling. *ASHRAE Journal* 1998;40(7):41–5.
- [97] Sabatelli V, Fiorenza G, Marano D. WP5.D1: technical status report on solar desalination and solar cooling. New Generation of Solar Thermal Systems; November 2005. http://www.swt-technologie.de/NEGST5_D1.PDF.
- [98] Hirunlabh J, Charoenwat R, Khedari J, Teekasap S. Feasibility study of desiccant air-conditioning system in Thailand. *Building and Environment* 2007;42(2):572–7.
- [99] Halliday SP, Beggs CB, Sleigh PA. The use of solar desiccant cooling in the UK: a feasibility study. *Applied Thermal Engineering* 2002;22(12):1327–38.
- [100] Mavroudaki P, Beggs CB, Sleigh PA, Halliday SP. The potential for solar powered single-stage desiccant cooling in southern Europe. *Applied Thermal Engineering* 2002;22(10):1129–40.
- [101] Mei L, Infield D, Eicker U, Loveday D, Fux V. Cooling potential of ventilated PV façade and solar air heaters combined with a desiccant cooling machine. *Renewable Energy* 2006;31(8):1265–78.
- [102] Ahmed MH, Kattab NM, Fouad M. Evaluation and optimization of solar desiccant wheel performance. *Renewable Energy* 2005;30(3):305–25.
- [103] Hassan MM, Beliveau Y. Modeling of an integrated solar system. *Building and Environment* 2008;43(5):804–10.
- [104] Joudi KA, Dhaidan NS. Application of solar assisted heating and desiccant cooling systems for a domestic building. *Energy Conversion and Management* 2001;42(8):995–1022.
- [105] Ali C, Bacha HB, Baccar M, Maalej AY. Dynamic modeling and simulation of a new air conditioning prototype by solar energy. *Renewable Energy* 2007;32(2):200–15.
- [106] Pramuang S, Exell RHB. The regeneration of silica gel desiccant by air from a solar heater with a compound parabolic concentrator. *Renewable Energy* 2007;32(1):173–82.
- [107] Panaras G, Mathioulakis E, Belessiotis V. Achievable working range for solid all-desiccant air-conditioning systems under specific space comfort requirements. *Energy and Buildings* 2007;39(9):1055–60.
- [108] Vitte T, Brau J, Chatagnon N, Woloszyn M. Proposal for a new hybrid control strategy of a solar desiccant evaporative cooling air handling unit. *Energy and Buildings* 2008;40(5):896–905.
- [109] Bourdoukan P, Wurtz E, Joubert P, Spérandio M. Potential of solar heat pipe vacuum collectors in the desiccant cooling process: modelling and experimental results. *Solar Energy* 2008;82(12):1209–19.
- [110] Pesaran AA, Wipke KB. Use of unglazed transpired solar collectors for desiccant cooling. *Solar Energy* 1994;52(5):419–27.
- [111] Russ C. Solar energy for hospitals. Hospital-Workshop, Florence; May 10, 2003. <http://www.taed.unifi.it/abitaweb/hospital/C.Russ.pdf>.
- [112] Solar powered desiccant cooling unit for air-conditioning of an office in Sintra, Portugal. <http://www.iea-shc-task25.org/english/hps2/pic3.html>.
- [113] Henning HM. Air conditioning with solar energy. Servitec, Barcelona; October 3, 2000. <http://www.eduvinet.de/servitec/henninge.pdf>.
- [114] Solar Heating and Cooling of Buildings, eco buildings Guidelines 2007. BRITA in PuBs. The 6th Framework Programme of the European Union. http://www.brita-in-pubs.eu/bit/uk/03viewer/retrofit_measures/pdf/FINAL_11_SolarCooling_Marco_01_4_08b.pdf.
- [115] Butera F, Adhikari RS, Aste N, Bracco R. Hybrid photovoltaic-thermal technology and solar cooling: the CRF solar facade case study. <http://www.pvdatabase.org/pdf/FIAT-SolarFacade.pdf>.
- [116] Solar Cooling, Innovative Solutions for Building Conditioning. Federation of Scientific and Technical Associations, Milan. European Commission-DG TREN within the 6th Framework Programme Contract No. TREN/05/F6EN/S07.54455/020114. http://ecobuilding-rtd-network.net/pdf_files/brochure_solar%20cooling_WP5_English.pdf.
- [117] Delorme M, Six R, Mugnier D, Quinette JY, Richler N, Heunemann F, et al., Solar air conditioning guide. http://www.cres.gr/climasol/index_files/pdf/climasol.pdf.
- [118] Murphy P. IEA Solar Heating & Cooling Programme, 2004 Annual Report. Washington, USA; 2005. http://www.iea-shc.org/publications/downloads/shc_annual_report_2004.pdf.
- [119] Mugnier D. IEA Task 25 demo projects & results of the EU Project Climasol; 2006. http://www.eurac.edu/NR/rdonlyres/6D32311A-5B67-4D17-90AA-ACD75CC9A802/0/Mugnier_Task25_Climasol.pdf.
- [120] Dai YJ. Solar cooling: research and application; October 8, 2008. <http://www.sjtuirc.sjtu.edu.cn/wangshangjiaoxue/xuekeqianyan/2008resource/daiyj.pdf>.
- [121] http://www.chinaheres.com/case_xxy.asp?id=7&fl=3.
- [122] Mazzei P, Minichiello F, Palma D. Desiccant HVAC systems for commercial buildings. *Applied Thermal Engineering* 2002;22(5):545–60.
- [123] Torrey M, Westerman J. Desiccant cooling technology—resource guide. U.S. Army Construction Engineering Research Laboratory; 2000. <http://www.wbdg.org/cdb/COOL/maindct1.pdf>.
- [124] Spears JW, Judge J. Gas-fired desiccant system for retail super center. *ASHRAE Journal* 1997;39(10):65–9.
- [125] Marciniak TJ, Koopman RN, Kosar DR. Gas-fired desiccant dehumidification system in a quick-service restaurant. *ASHRAE Transactions* 1991;(pt 1): 657–66.
- [126] Miller JA, Lowenstein A, Sand JR. The performance of a desiccant-based air conditioner in a Florida school. *ASHRAE Transactions* 2002;108(PART 1): 575–86.
- [127] Fischer J, Sand J. Field test and performance verification: integrated active desiccant rooftop hybrid system installed in a school, final report: phase 4a. Oak Ridge National Laboratory; 2005. ORNL/SUB/01/4000025209.
- [128] Fischer J, Sand J. Desiccant-based combined systems: integrated active desiccant rooftop hybrid system development and testing, final report: phase 4. Oak Ridge National Laboratory; 2004. ORNL/SUB/01/4000010402.
- [129] Fischer J, Mescher K, Elkin B, McCune SM, Gresham J. High-performance schools. *ASHRAE Journal* 2007;49(5):30–46.
- [130] Currie G. Hornsby Central Library Project ‘Greenhouse-friendly power and air-conditioning’. CSIRO Energy Technology. <http://www.det.csiro.au/PDF%20files/hornsbylp.pdf>.
- [131] Kohlenbach P, Bongs C, White S, Ward J. Performance modelling of a desiccant evaporative sorption air conditioning system driven by micro-turbine waste heat in tropical climates. *Ecolibrium* 2006/January 2007; 25–31.
- [132] Popovic P, Marantan A, Radermacher R, Garland P. Integration of micro-turbine with single effect exhaust-driven absorption chiller and solid wheel desiccant system. *ASHRAE Transactions* 2002;108(Part 2):660–9.
- [133] Garland PW. Recycling waste heat—CHP as an alternative. Waste heat to power generation workshop; 2005. University of California, Irvine, Oak Ridge National Laboratory for U.S. Department of Energy. http://www.chpcentermw.org/NwChpDocs/ChpWkshop_20050302_RecyclingWasteHeat_Garland.ppt.
- [134] Schmitz G, Casas W. Experiences with a small gas engine driven desiccant HVAC-system. In: Proceedings of the 2001 international gas research conference; 2001.
- [135] Schmitz G, Casas W. Gas driven, desiccant assisted air conditioning of an office building in Hamburg, Germany. In: Proceedings of the 2004 international gas research conference proceedings; 2004.
- [136] Schmitz G, Joos A, Casas W. Experiences with thermal driven, desiccant assisted air conditioning systems in Germany. In: Proceedings of ASME international mechanical engineering congress and exposition, vol. 15; 2008. p. 219–26.